



STATE OF MAINE
MAINE REVENUE SERVICES

PT103

Valuation of Real Estate

Revised September, 2022

The Department of Administrative and Financial Services does not discriminate on the basis of disability in admission to, access to, or operation of its programs, services or activities. This material can be made available in alternate formats by contacting the Department's ADA Coordinator at (207) 624-8288 (voice) or 7-1-1 (V/TTY).

PHONE: (207) 624-5600 V/TTY: (207) 7-1-1 FAX: (207) 287-6396 EMAIL: prop.tax@maine.gov
www.maine.gov/revenue/propertytax

TABLE OF CONTENTS

FOREWORD	i
Chapter 1 INTRODUCTION – THE BASICS	
The Market Approach.....	2
The Income Approach.....	2
The Cost Approach.....	3
The Four Great Forces.....	4
Economic Principles of Valuation.....	5
Cost, Value, and Price.....	6
Data Collection.....	7
The Assessment Process.....	9
Chapter 2 LAND VALUATION	
Developed Lots.....	11
Land Valuation Methods.....	11
Front Foot Valuation.....	12
Depth Factors.....	12
Depth Factors Table.....	14
Land Value Reference Sheet.....	15
Class Problems.....	16
Square Foot Valuation.....	30
Front and Rear Acre Valuation.....	31
Factors Affecting Land Value.....	31
Chapter 3 MEASURING AND LISTING	
Measuring the Property.....	33
Sketching the Property.....	34
Suggested Abbreviations.....	35
Class Problems.....	37
Grading the Property.....	38
Class Problems.....	39
Property Record Cards.....	45
Grading Schedules.....	47
Chapter 4 THE COST APPROACH	
Alternatives to Cost Schedules.....	55
Manufactured Housing.....	56
Farm Properties.....	56
Commercial and Industrial Properties.....	57
Class Problem.....	58
Steps in the Cost Approach.....	58
Use of Cost Schedules.....	59

Current Cost Factor.....	62
Garages and Outbuildings.....	62
Cost Schedules	63
Depreciation and Condition	76
Direct Method of Depreciation.....	77
Physical Deterioration	78
Functional Obsolescence	78
External Obsolescence	79
Class Problem	85

Chapter 5 THE MARKET APPROACH

Procedure.....	88
Comparative Market Analysis.....	88
Class Problem.....	91
Paired Sales Analysis.....	93
Class Problem.....	97

Chapter 6 THE INCOME APPROACH

Definitions	100
Income	102
Class Problem.....	104
Capitalization.....	104
Steps in the Direct Capitalization Process.....	105
Determining the Capitalization Rate.....	106
Class Problem	107
Calculating Value	108
Class Problems	111

Chapter 7 SALES RATIO STUDIES

Introduction	117
Verification of Data.....	117
Time Period for Sales.....	118
Definitions	119
Class Problems	124

ANSWERS TO CLASS PROBLEMS

Chapter 2 answers	133
Chapter 3 answers	147
Chapter 4 answers	152
Chapter 5 answers	154
Chapter 6 answers	158
Chapter 7 answers	166

FOREWORD

This is the third course in a series of introductory courses offered by the Maine Property Tax Division as part of the state's training and certification program for property taxation. This course text represents an ongoing commitment to provide education and training for assessors and those who wish to become assessors. 36 M.R.S. § 318 states, in part:

The State Tax Assessor may establish, either on the assessor's own initiative or in conjunction with professional or educational agencies, or both, a program of training to meet the needs of the State of Maine for a sufficient supply of competently trained assessors.

The material contained in this text is designed to be an introduction to generally accepted practices for valuation of residential property, which dominates the property tax base in most Maine municipalities. This course material is used in combination with the *State of Maine Assessment Manual* for the introductory course PT103.

CHAPTER 1

INTRODUCTION – THE BASICS

The purpose of this text is to introduce the three approaches to valuation of property for tax assessment purposes, the market approach, the income approach, and the cost approach. All three approaches lead to estimates of market value (also referred to as “current market value”) for property within a municipality.

Assessors are required to value all property within their municipalities. The Maine Constitution requires a “general valuation” at least once every ten years. This requirement does not mean a municipality must contract with a valuation company to do a complete municipal revaluation, but an occasional revaluation can be a valuable tool for maintaining just value throughout a municipality.

Almost all property is subject to competing uses. When estimating market value, the assessor must determine which of the competing uses is the highest and best. Highest and best use is the legally allowable use that will generate the highest return to the property over time. The highest and best use of any property must meet the following four criteria.

1. Physically possible and probable
2. Legally permissible
3. Financially feasible
4. Most productive (either income generated for a business or available amenities for an individual)

The goal of any valuation procedure is to establish just value. Just value means market value. Market value is the price a willing buyer will pay for a property offered by a willing seller, with no additional influences such as the need to sell quickly or the buyer and seller being related to each other. Assessed value, or the value of property according to the local assessor, must be based on just value, but doesn't have to equal just value. Assessed value can be equal to, greater than, or less than market value, as long as all other properties in the municipality are valued at the same relation to market value. For example, if a property is assessed at 85% of market value, that property is assessed according to just value if all property in that municipality is also assessed at 85% of market value.

The definition of market value as adopted by the Appraisal Institute and the International Association of Assessing Officers (IAAO) is as follows:

The most probable price which a property should bring in a competitive and open market under all conditions requisite to a fair sale, the buyer and seller each acting prudently and knowledgeably and assuming the price is not affected by undue stimulus. Implicit in this definition is the consummation of a sale as of a specified date and the passing of title from seller to buyer under conditions whereby:

- A. Buyer and seller are typically motivated;*
- B. Both parties are well informed or well advised and acting in what they consider their best interests;*
- C. A reasonable time is allowed for exposure to the open market*
- D. Payment is made in terms of cash in U.S. dollars;*
- E. And the price represents the normal consideration for the property sold unaffected by special or creative financing or sales concessions granted by anyone associated with the sale.*

The Market Approach

The market approach is the valuation method most often employed by independent appraisers for purposes of determining value for one parcel of land and all the buildings on it (single property appraisal). Assessors use this approach to verify the cost approach to valuation by comparing a few comparable sales to the subject property. With the market approach, an estimate of value for a subject property is determined by adjusting the selling price of properties closely matching the subject.

The market approach to valuation creates an estimate of property value based on recent property sales in a municipality. These recent sales are combined into an analysis called a ratio study. A sufficient number of sales are required to conduct a proper ratio study. The Maine Property Tax Division generally requires at least 12 sales to conduct a ratio study (see Maine Revenue Services Rule 201, § 03(B)(1)). A qualified sales ratio study is the best support for determining an estimate of value.

The Income Approach

The income approach to valuation creates an estimate of value based on the future income potential of a property. There are three major components in the formula used in the income approach. They are income, (capitalization) rate and value. The formula is often referred to as the “IRV” formula.

$$\text{Income} = \text{Rate} \times \text{Value}$$

Alternately, $\text{Rate} = \text{Income}/\text{Value}$ or $\text{Value} = \text{Income}/\text{Rate}$

The Cost Approach

The cost approach to valuation is the primary method assessors use to arrive at an estimate of value for the purposes of mass appraisal. Mass appraisal, unlike single property appraisal, is the valuation of many properties, such as all property in a municipality, using a uniform technique. This uniform technique must be broad enough to apply to all the different types of property in a municipality (residential, commercial, industrial, agricultural, etc.). The cost approach is based on several appraisal principles.

The cost approach is designed to arrive at the cost of replacing a structure for the same use rather than creating an exact duplicate of that structure. For example, consider a Victorian-era home. Most likely, an older home like this will have tin ceilings, a stone foundation, and novelty, decorative trim on the outside. A new home will usually not have these features. In most cases, a new home is constructed according to current standards and building codes and the cost of replacing this home, rather than recreating it, will include standard modern features, such as drywall and a concrete foundation. This replacement cost is the basis of the cost approach. When properly applied, the cost approach should return a value estimate of a home with similar usable space and of comparable quality.

The replacement cost will usually set the upper limit of value. The cost to construct a building should not exceed what it would cost to purchase an existing, similar building.

For example, you must value a 3,000-square-foot ranch on a standard lot. A builder will construct this type of house for \$100 per square foot, or \$300,000. Add to this the cost of raw land, for this example, \$50,000, and necessary site improvements (access to water, sewer and electricity), \$30,000. The costs together will approximate the market value of the property, or about \$380,000.

This concept is fine if you must value new buildings. For older property, adjustments must be made to account for aging. The cost approach applies depreciation to the replacement cost to determine value.

Current assessment technique is a marriage between the cost approach and the market approach.

The cost approach forms the basis for determining the replacement cost new (RCN) of a structure. Older structures, however, must have the RCN adjusted downward to represent value lost due to wear and tear, lack of functionality or value lost because

of location influences – replacement cost new less depreciation and obsolescence (functional and external). The standard name for this adjusted replacement cost is replacement cost new less depreciation or, RCNLD.

The Four Great Forces

Four general forces affect the market value of property. These forces – called the Four Great Forces – are called Physical, Economic, Governmental, and Social (referred to as P.E.G.S). Each of these forces can affect the value of property either adversely or positively. The following are examples of each of the Four Great Forces.

1. Physical forces:
 - a. Topography
 - b. Lot shape, soil conditions
 - c. Access to services, i.e., parks, stores, employment, schools, churches, transportation

Topography of a sharp, steep nature may be desirable if the buyer is looking for sweeping views on a water body; however, a homeowner may be reluctant to pay a great deal of money for a property if the driveway has a 45-degree slope.

2. Economic forces:
 - a. Income trends
 - b. Lending policies and interest rates
 - c. Construction costs
 - d. Housing prices and rental rates
 - e. Availability of vacant land

A solitary manufacturing plant layoff can decimate a rural municipality due to lost salaries, while low interest rates may make borrowing more affordable.

3. Governmental forces:
 - a. Zoning
 - b. Building codes
 - c. Municipal services
 - d. Taxes

Governmental forces play a large role in the development of property. Subdivision or shoreland zoning regulations can have a profound effect on value. Property value is often enhanced because of zoning laws that prevent sprawl and may be reduced if police or fire protection is cut back.

4. Social forces:
 - a. Population trends, age distribution
 - b. Family size
 - c. Education trends
 - d. Crime rates

There are times when social forces may be paramount in the buying process. For instance, the family with teenage children may desire to live near the area high school, while a retired couple might prefer a home close to a golf course or library.

Economic Principles of Valuation

The following economic principles work in concert with the Four Great Forces in the development and evolution of property markets and value.

The principle of **anticipation** says that market value is the present worth of all anticipated future benefits derived from the property. Those benefits must be either income or amenities. The assessor should not allow personal opinion to influence the determination of anticipated future benefits. This is difficult to determine because of the principle of change.

The principle of **balance** says that market value is maximized when the four agents of production (land, labor, capital, and management) attain a state of equilibrium. When applied to a neighborhood, this means that the value of a property is at its peak when the neighborhood has all the services it needs. Value is reduced if there are too few or too many services in a neighborhood.

The principle of **change** says that the market is never constant, because physical, economic, government, and social (PEGS) forces are always at work to change the property.

The principle of **competition** says that competition is created when the potential for profit, or the existence of new amenities attracts new sellers and buyers to a market. An excess of one type of property will tend to decrease the value of other properties.

The principle of **conformity** says that the more a property is in harmony with its surroundings, the greater the contributory value. Maximum market value is achieved when there is reasonable similarity among the improvements (houses and other additions to the land) in a neighborhood, and when the residents have similar ages, incomes, education, attitudes, etc.

The principle of **consistent use** says that property must be valued with a single use for the entire property. Improvements to the land must be valued on the same basis.

Improvements to the land must contribute to the land value to have any value themselves. It is improper to value a property on a basis of one use for the land and another use or uses for the improvements. For example, if a house is valued as residential property, the driveway should not be valued according to its worth as commercial property.

The principle of **contribution** says that the value of one component of a property depends on its contribution to the whole. For example, a residential homeowner spends \$20,000 to erect a garage. If the market value of his property is only increased by \$15,000, then \$15,000 is the value contribution of the garage.

The principle of **diminishing returns** says that additional investment in a property will increase the return up to a certain point, and then, beyond this point, the return on additional capital decreases. For example, adding a second bathroom to a house may cost \$10,000 and increase the value of the home by \$15,000, but adding a third bathroom, which would also cost \$10,000, may only increase the value of the home by \$2,000.

The principle of **progression and regression** says that the value of lower priced properties may be increased by proximity to better properties of the same type. Likewise, a better quality property will decrease in value by proximity to lower quality properties in the same area.

The principle of **substitution** says that the market value of a property tends to be set by the cost of acquiring an equally desirable and valuable substitute property. This principle is a fundamental driver of the three approaches to value (cost, market, and income).

The principle of **supply and demand** says that the value of a property increases with increased demand and decreases with increased supply. Conversely, the value of a property decreases with decreased demand, such as with a recession and increases with a limitation on supply by, for example, a building moratorium.

The principle of **surplus productivity** says the income attributable to land equals the income remaining after the costs of labor, capital, and management have been subtracted.

Cost, Value, and Price

Each of the terms “cost,” “value,” and “price” has a different definition and, depending on the situation, may or may not mean the same thing as the other terms.

Value is defined as the importance or usefulness of an item. Value is sometimes referred to as the present worth of future benefits. Value is what a well-informed, intelligent buyer, acting voluntarily and without necessity will pay for a property. Value can be measured by productivity – the net return in utility, satisfaction, or dollars.

Cost is the summary of expenditures necessary to create something.

Price is the goods or commodities asked or paid for other goods and commodities.

Therefore, the value of a property may be the sum of its costs. It may be represented by the price paid for the property. Yet, the value of a property may not be either cost or price. Ultimately, value is set by the marketplace.

Data Collection

All three approaches to valuation are dependent on data. There are several different types of data necessary for each approach. All data collected must be current to accurately reflect market value.

Some sources of data are:

- Declaration of value forms – Real Estate Transfer Tax forms
- Deeds
- Mortgages
- Newspaper or online advertisements (asking prices – not sales prices)
- Redfin, Zillow, or other online real estate databases
- Realtors
- Banks
- Real estate trade magazines, websites, and periodicals
- Property owners who have bought and sold property (sales qualification forms)
- Contractors
- Commercial cost schedules
- Field reviews

Once the data has been collected, it must be analyzed to determine any effect on market value. Property type, locations, services provided, and quality are just some of the types of analyses to be performed. It is important to determine how these different property characteristics affect the market value of property. These studies vary depending on the types of property in your jurisdiction.

Data on the specific properties to be assessed must be collected. This involves a program of uniformly measuring and listing characteristics of each property to allow

for the consistent application of pricing units and formulas. A specially designed data collection form needs to be completed for each property. This information is then transferred to a property record card listing the details of the structure, other improvements, land and parcel background along with the determination of value data.

These data cards are related to a geographic locator on a map or grid. Most Maine jurisdictions use tax maps. Cards on each specific property are ordered by the map, lot and or block number of its location. This land-based system is the most secure, as property, generally speaking, does not move. A coordinate on the face of the earth is for the most part, stationary and will always provide an accurate reference to location.

The Assessment Process

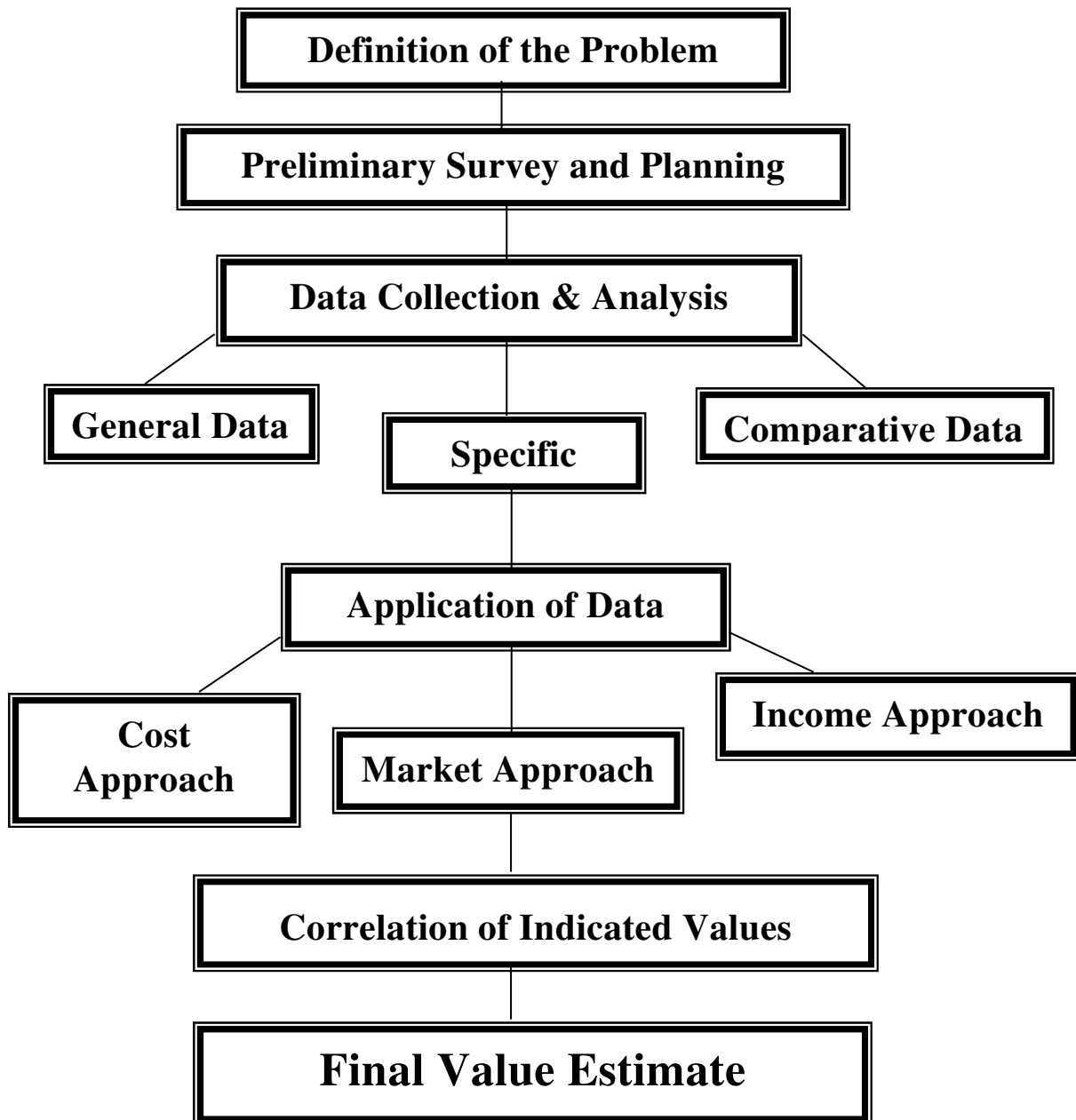

CHAPTER 2

LAND VALUATION

The valuation of land usually involves the combination of the market approach and the cost approach. The value of land can be determined through analysis of land sales. Since sales of land only are sometimes rare, land may also be valued by subtracting the value of improvements (buildings on the land) from the sale price of improved property. This is the allocation method. The costs to improve land are determined through construction cost schedules.

For commercial and industrial property, it is possible to apply the income approach to value land by capitalizing the income attributed to land. The method of valuing land through the income approach is called a land residual calculation. Land residual is a method to determine the value of land by subtracting income attributable to the building from the net operating income and valuing the residual land income. This technique will be discussed in Chapter 6, The Income Approach.

Developed Lots

A lot, to be classified as developed, must have significant improvements. The fact that a lot has a building on it does not, by itself, make the lot developed. Items to consider when determining whether a lot is developed include a dependable water supply, a functioning septic system, access to electricity, landscaping, and an acceptable driveway (usually gravel or paved).

The most important aspects of a developed lot are the water supply and the septic system. A spring or shallow dug well without a septic system would normally not justify a developed parcel. It is possible to have a developed lot without water or septic, but that is a rare situation involving extensive improvements to the land otherwise.

Land Valuation Methods

The State of Maine requires assessors to determine and report land values separately from the value of improvements (buildings and other items affixed to land). There are certain tools and procedures available to enable this process.

Tax maps are the first tool used in the valuation of land. Sales of land supply the necessary underlying valuation data. Plotting land sales on maps helps visualize the

array of values throughout the jurisdiction. A site inspection verifies the use of the property and any improvements.

Establishing a land pricing schedule helps establish equitable land values throughout the jurisdiction. These schedules are developed from local land sales. Types of pricing schedules include front foot valuation, square foot valuation, and front and rear acre valuation.

Front Foot Valuation

This method establishes the value of one foot of frontage – usually on a road or a body of water – with a parcel depth equal to a standard size lot for the area. This value is called the front foot value or, sometimes, the unit front foot value. Depth factors adjust the front foot value for differing parcel depths, so that one front foot of a parcel shallower than the standard depth is valued less than the standard amount. Conversely, one front foot of a parcel deeper than standard will be valued at more than the standard rate by applying a depth factor. The value of a parcel is equal to the front foot value (FFV) multiplied by the depth factor (DF) multiplied by the number of feet of frontage (FF) for the property.

$$\text{Value} = \text{FFV} \times \text{DF} \times \text{FF}$$

Front foot valuation is best suited to properties of consistent size and shape, such as subdivisions or typical downtown lots.

Depth Factors

The adjusted front foot value of a parcel twice as deep as standard is ordinarily less than twice the standard front foot value. The front foot value of a parcel half as deep as standard is ordinarily more than half the standard value. As a result, the calculation of depth factors is usually not a straight correlation. The depth factor calculation used in this text is equal to the square root of the subject lot depth divided by the standard lot depth, or:

$$\text{Depth Factor} = \sqrt{(\text{parcel depth}/\text{standard depth})}$$

Where “parcel depth” is the depth of the subject lot and “standard depth” is the depth of a standard lot. For example, the depth factor calculation for a lot that is 125 feet deep in a neighborhood where the standard lot depth is 100 feet is:

$$\text{DF} = \sqrt{(125/100)} = \sqrt{1.25} = 1.12$$

Chapter 2 – Land Valuation

If the subject lot depth is equal to the standard depth, the depth factor will be 1.00.

To calculate the value of a parcel using the front foot value method, you must perform two steps:

- 1) determine or calculate the depth factor (DF); and
- 2) calculate the parcel value.

To calculate the depth factor, use the depth factor equation from above.

$$DF = \sqrt{(\text{parcel depth}/\text{standard depth})}$$

To calculate the parcel value, multiply the front foot value by the depth factor and the number of frontage (or front) feet for the parcel.

$$\begin{aligned} \text{Parcel Value} &= (\text{FFV} \times \sqrt{(\text{parcel depth}/\text{standard depth})}) \times \text{FF} \\ &= \text{FFV} \times \text{DF} \times \text{FF} \end{aligned}$$

Depth Factor Table

The following table of percentage factors is designed to give a uniform method of adjusting the value per front foot, up or down, depending on whether the lot is more or less than the standard depth.

Depth In Feet	Factor 100 Ft. <u>Standard</u>	Factor 125 Ft. <u>Standard</u>	Factor 150 Ft. <u>Standard</u>	Factor 200 Ft. <u>Standard</u>	Factor 220 Ft. <u>Standard</u>	Factor 250 Ft. <u>Standard</u>
10	0.32	0.28	0.26	0.22	0.21	0.20
15	0.39	0.35	0.32	0.27	0.26	0.24
20	0.45	0.40	0.37	0.32	0.30	0.28
25	0.50	0.45	0.41	0.35	0.34	0.32
30	0.55	0.49	0.45	0.39	0.37	0.35
35	0.59	0.53	0.48	0.42	0.40	0.37
40	0.63	0.57	0.52	0.45	0.43	0.40
45	0.67	0.60	0.55	0.47	0.45	0.42
50	0.71	0.63	0.58	0.50	0.48	0.45
55	0.74	0.66	0.61	0.52	0.50	0.47
60	0.77	0.69	0.63	0.55	0.52	0.49
65	0.81	0.72	0.66	0.57	0.54	0.51
70	0.84	0.75	0.68	0.59	0.56	0.53
75	0.87	0.77	0.71	0.61	0.58	0.55
80	0.89	0.80	0.73	0.63	0.60	0.57
85	0.92	0.82	0.75	0.65	0.62	0.58
90	0.95	0.85	0.77	0.67	0.64	0.60
95	0.97	0.87	0.80	0.69	0.66	0.62
100	1.00	0.89	0.82	0.71	0.67	0.63
105	1.02	0.92	0.84	0.72	0.69	0.65
110	1.05	0.94	0.86	0.74	0.71	0.66
115	1.07	0.96	0.88	0.76	0.72	0.68
120	1.10	0.98	0.89	0.77	0.74	0.69
125	1.12	1.00	0.91	0.79	0.75	0.71
130	1.14	1.02	0.93	0.81	0.77	0.72
135	1.16	1.04	0.95	0.82	0.78	0.73
140	1.18	1.06	0.97	0.84	0.80	0.75
145	1.20	1.08	0.98	0.85	0.81	0.76
150	1.22	1.10	1.00	0.87	0.83	0.77
160	1.26	1.13	1.03	0.89	0.85	0.80
170	1.30	1.17	1.06	0.92	0.88	0.82
180	1.34	1.20	1.10	0.95	0.90	0.85
190	1.38	1.23	1.13	0.97	0.93	0.87
200	1.41	1.26	1.15	1.00	0.95	0.89
210	1.45	1.30	1.18	1.02	0.98	0.92
220	1.48	1.33	1.21	1.05	1.00	0.94
230	1.52	1.36	1.24	1.07	1.02	0.96
240	1.55	1.39	1.26	1.10	1.04	0.98
250	1.58	1.41	1.29	1.12	1.07	1.00
300	1.73	1.55	1.41	1.22	1.12	1.05
350	1.87	1.67	1.53	1.32	1.17	1.10
400	2.00	1.79	1.63	1.41	1.22	1.14
450	2.12	1.90	1.73	1.50	1.43	1.18
500	2.24	2.00	1.83	1.58	1.51	1.22

Land Value Reference Sheet

FFV = Front Foot Value

DF = Depth Factor = $\sqrt{(\text{parcel depth}/\text{standard depth})}$

FF = Number of Front Feet

TF = Triangle Factor = 0.60 for delta triangle (base on street); 0.30 for nabra triangle (point on street)

ML = Merge Line



Rectangular Parcel

Value = FFV x DF x FF



Rear Rectangular Parcel



Value = FFV x DF x FF, where $DF = DF_{\text{TOTAL AREA}} - DF_{\text{FRONT PARCEL}}$

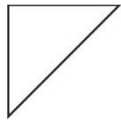
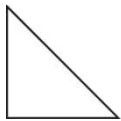

Triangular Parcel

Value = FFV x DF x FF x TF

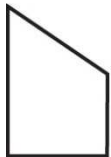

Trapezoidal Parcel

1) Both sides perpendicular to street:

Value = FFV x DF x FF, where DF is based on average depth

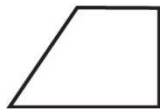

2) One side at an oblique angle to street:

Split into rectangular parcel and triangular parcel

Value = Value_{RECTANGLE} + Value_{TRIANGLE}



Parallelogram Parcel

Value = FFV x DF x FF, where DF is based on perpendicular depth

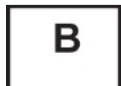

Parcel with Frontage on Two Streets

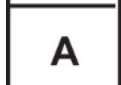

$ML_A = FFV_A \times (\text{parcel depth}/(FFV_A + FFV_B))$

$ML_B = \text{parcel depth} - ML_A$

Value as two separate rectangular parcels from street to ML

Class Problems

Answers on page 133

Valuation of Rectangular Parcels

To calculate the value of a rectangular parcel, follow the three front foot value method steps and round the answer to the nearest \$100.

Example. Standard depth = 220ft; FFV = \$350/ft

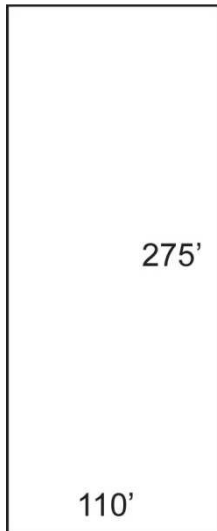

$$\begin{aligned} 1) \text{ DF} &= \sqrt{(\text{parcel depth}/\text{standard depth})} \\ &= \sqrt{(275\text{ft}/220\text{ft})} = \sqrt{1.22} = 1.12 \end{aligned}$$

$$\begin{aligned} 2) \text{ Parcel Value} &= \text{FFV} \times \text{DF} \times \text{FF} = \$350/\text{ft} \times 1.12 \times 110\text{ft} = \\ & \$43,120, \text{ rounded to } \underline{\$43,100} \end{aligned}$$

Calculate the value for each of the parcels below. Assume the street frontage is at the bottom of each diagram.

Problem 2.1. Standard depth = 220ft; FFV = \$350/ft

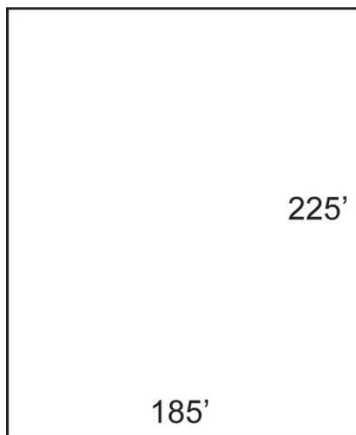

Valuation of Rear Rectangular Parcels

The valuation of a rear rectangular parcel follows the same three step process as with rectangular parcels, but with one additional step. Rather than calculating one depth factor, we have to calculate two depth factors and use the difference between the two in the rear parcel valuation. The two depth factors to calculate are: 1) for the entire property; and 2) for the front parcel. The depth factor for the entire property (DF_{A+B}) less the depth factor for the front parcel (DF_A) equals the depth factor for the rear parcel (DF_B).

Example. Standard depth = 200ft; FFV = \$300/ft

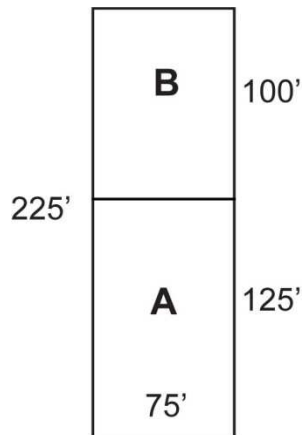

$$1) DF_{A+B} = \sqrt{(\text{parcel depth}/\text{standard depth})}$$

$$= \sqrt{(225\text{ft}/200\text{ft})} = \sqrt{1.13} = 1.06$$

$$DF_A = \sqrt{(\text{parcel depth}/\text{standard depth})}$$

$$= \sqrt{(125\text{ft}/200\text{ft})} = \sqrt{0.63} = 0.79$$

$$DF_B = 1.06 - 0.79 = 0.27$$

$$2) \text{ Parcel B Value} = \text{FFV} \times DF_B \times \text{FF} = \$300/\text{ft} \times 0.27 \times 75\text{ft} =$$

$$\$6,075, \text{ rounded to } \underline{\$6,100}$$

Chapter 2 – Land Valuation

Calculate the value for parcel B for each of the properties below. Assume the street frontage is at the bottom of each diagram.

Problem 2.2. Standard depth = 220ft; FFV = \$175/ft

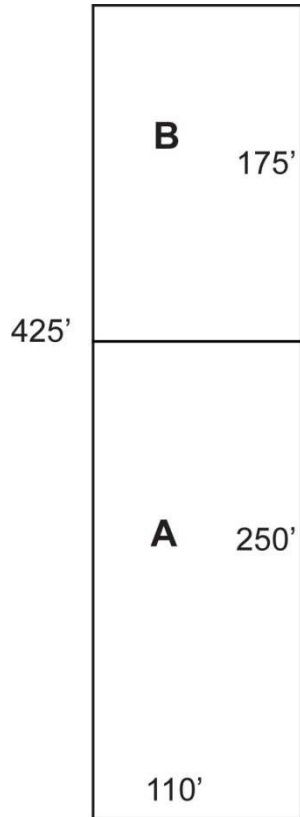

Valuation of Triangular Parcels

The valuation of a triangular parcel follows the same three step process as with rectangular parcels, but with one additional step. The parcel value calculation in step three requires the application of a multiplier, called a “triangular factor.” The triangular factor is either 0.60 or 0.30, depending on the orientation of the parcel with the street.

A triangular parcel with its wide end abutting the street is called a “delta triangle” and has a triangle factor of 0.60 (TF_D). A triangular parcel with its narrow end abutting the street is called a “nabla triangle” and has a triangle factor of 0.30(TF_N).

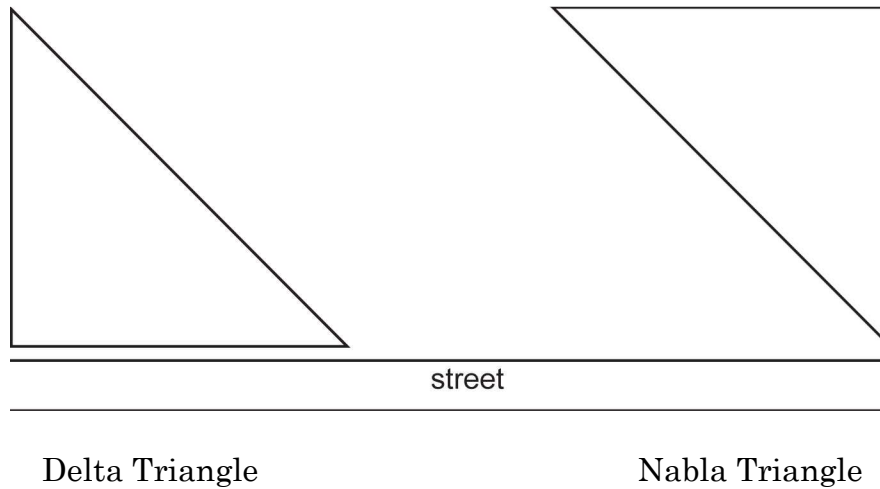

Example. Standard depth = 125ft; FFV = \$350/ft

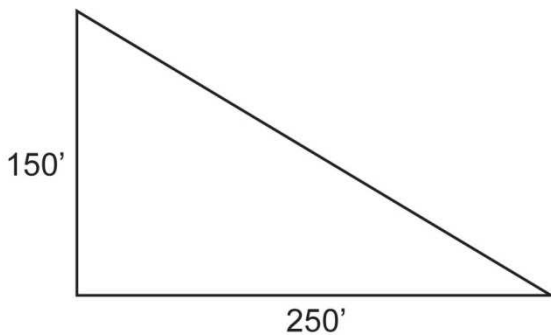

$$1) DF = \sqrt{(\text{parcel depth}/\text{standard depth})} \\ = \sqrt{(150\text{ft}/125\text{ft})} = \sqrt{1.20} = 1.10$$

$$2) \text{ Parcel Value} = \text{FFV} \times \text{DF} \times \text{FF} \times \text{TF}_D = \\ \$350/\text{ft} \times 1.10 \times 250\text{ft} \times 0.60 = \$57,750, \\ \text{rounded to } \underline{\underline{\$57,800}}$$

Chapter 2 – Land Valuation

Calculate the parcel value for each of the properties below. Assume the street frontage is at the bottom of each diagram.

Problem 2.3. Standard depth = 125ft; FFV = \$350/ft

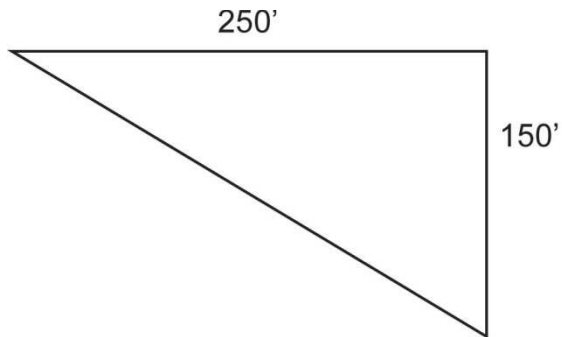

Problem 2.4. Standard depth = 125ft; FFV = \$325/ft

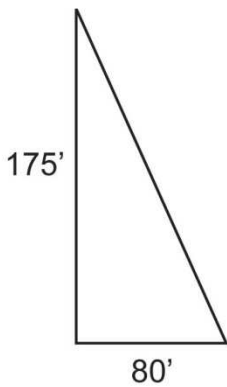

Valuation of Trapezoidal Parcels

Trapezoidal parcels can be oriented at right angles to the street (or other frontage) or an oblique angle to the street.

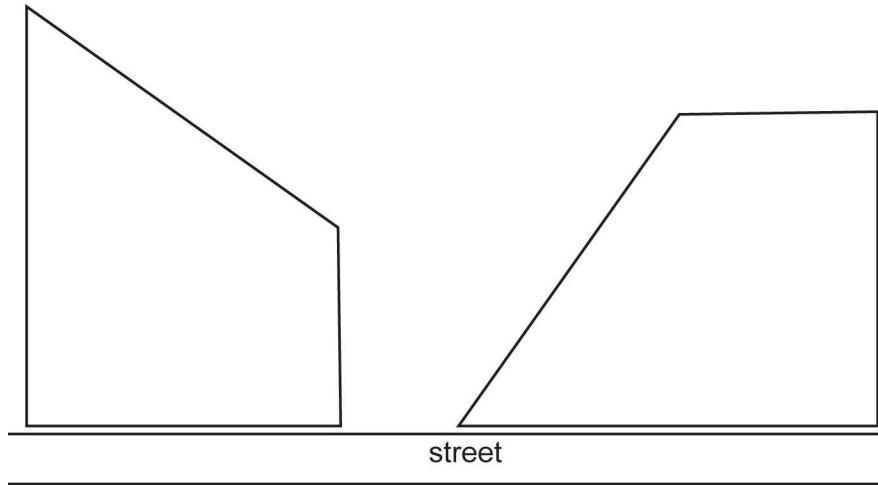

Trapezoid at right angles

Trapezoid at an oblique angle

The valuation of a trapezoidal parcel at right angles to the street follows the same three step process as with rectangular parcels, but with one additional step. The parcel depth is equal to the average depth of the parcel. To calculate the average depth, add the long side depth and the short side depth and divide the total by two. The average depth is used in the same three step calculation as with a rectangular parcel.

Example. Standard depth = 125ft; FFV = \$200/ft

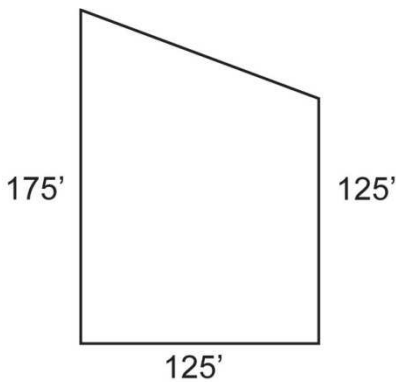

$$\text{Average depth} = (175\text{ft} + 125\text{ft})/2 = 300\text{ft}/2 = 150\text{ft}$$

$$1) \text{ DF} = \sqrt{(\text{parcel depth}/\text{standard depth})} \\ = \sqrt{(150\text{ft}/125\text{ft})} = \sqrt{1.20} = 1.10$$

$$2) \text{ Parcel Value} = \text{FFV} \times \text{DF} \times \text{FF} = \$200/\text{ft} \times 1.10 \times 125\text{ft} = \underline{\underline{\$27,500}}$$

Calculate the parcel value for each of the properties below. Assume the street frontage is at the bottom of each diagram.

Problem 2.5. Standard depth = 125ft; FFV = \$200/ft

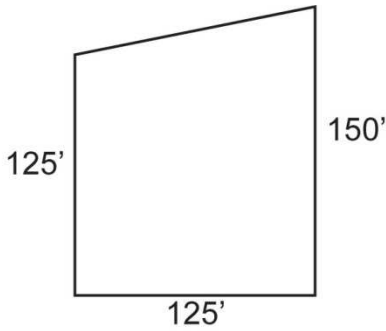

The valuation of a trapezoidal parcel at an oblique angle to the street requires two separate parcel valuations, one for the rectangular portion and the other for the triangular portion. The total parcel value is the sum of these two separate calculations.

Example. Standard depth = 125ft; FFV = \$200/ft

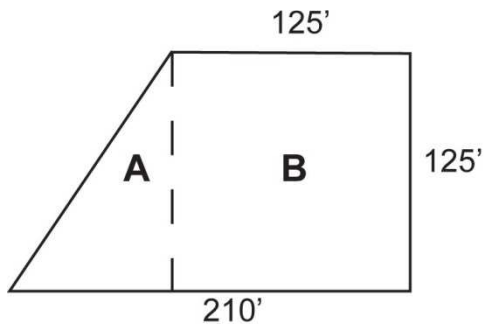

$$1) DF_A = \sqrt{(\text{parcel depth}/\text{standard depth})} \\ = \sqrt{(125\text{ft}/125\text{ft})} = \sqrt{1.00} = 1.00$$

$$2) \text{Value}_A = \text{FFV} \times DF_A \times \text{FF}_A \times \text{TF}_D = \$200/\text{ft} \times 1.00 \\ \times (210\text{ft} - 125\text{ft}) \times 0.60 = \$200/\text{ft} \times 85\text{ft} \times 0.60 \\ = \underline{\$10,200}$$

$$1) DF_B = \sqrt{(\text{parcel depth}/\text{standard depth})} \\ = \sqrt{(125\text{ft}/125\text{ft})} = \sqrt{1.00} = 1.00$$

$$2) \text{Value}_B = \text{FFV} \times DF_B \times \text{FF}_B = \$200/\text{ft} \times 1.00 \times 125\text{ft} = \underline{\$25,000}$$

$$\text{Parcel Value} = \text{Value}_A + \text{Value}_B = \$10,200 + \$25,000 = \underline{\underline{\$35,200}}$$

Calculate the parcel value for each of the properties below. Assume the street frontage is at the bottom of each diagram.

Problem 2.6. Standard depth = 125ft; FFV = \$240/ft

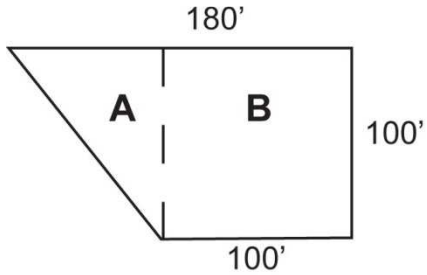

Valuation of Parallelogram Parcels

The valuation of a parallelogram parcel follows the same three step process as with rectangular parcels, except that the depth factor is based on the perpendicular depth of the parcel.

Example. Standard depth = 150ft; FFV = \$100/ft

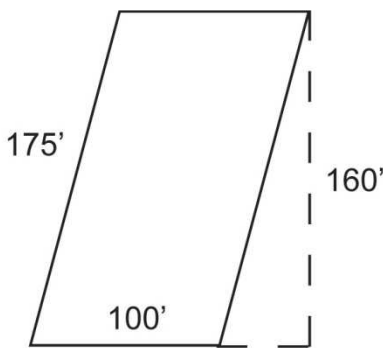

$$1) \text{ DF} = \sqrt{(\text{parcel depth}/\text{standard depth})} \\ = \sqrt{(160\text{ft}/150\text{ft})} = \sqrt{1.07} = 1.03$$

$$2) \text{ Parcel Value} = \text{FFV} \times \text{DF} \times \text{FF} = \$100/\text{ft} \times 1.03 \times 100\text{ft} = \underline{\underline{\$10,300}}$$

Calculate the parcel value for each of the properties below. Assume the street frontage is at the bottom of each diagram.

Problem 2.7. Standard depth = 125ft; FFV = \$330/ft

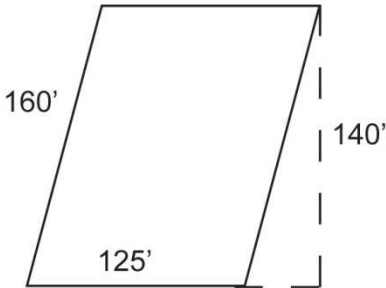

Valuation of Parcels with Frontage on Two Streets

Commonly known as through-lots, parcels with frontage on two streets are primarily found in business or commercial areas. This valuation is also applicable in those residential areas where the back frontage is adapted and adaptable for house lots of sufficient size and would comply with building and zoning codes and ordinances.

If the through-lot is not of a sufficient depth to compute value on each street, the customary approach is to consider the applicable depth influence range in direct proportion to the unit front foot values of the front and back streets. The first step to determining the value is to find the merge line. The merge line calculation takes into consideration the higher market value of the property due to the influence from the street with a higher front foot value. Once the merge line is determined, the parcel is valued as two separate lots, following the three-step process for rectangular parcels. The separate values are then combined to a total value.

To calculate the merge line, follow these three steps:

- a) Add the front foot values (FFV_{TOTAL});
- b) Divide the total parcel depth by FFV_{TOTAL} from step 1 (merge factor); and

c) Multiply one of the front foot values (it doesn't matter which one) by the merge factor from step 2 (merge line). The result is the depth of that parcel section as measured from the street associated with the front foot value you used.

Once you have calculated the merge line, determine the value of each section of the parcel, using the standard two-step formula, and add values together to find the total parcel value.

Example.

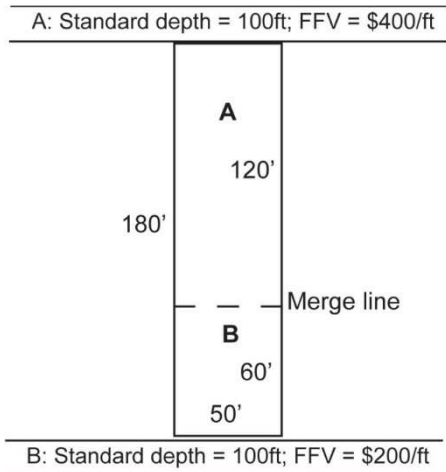

Merge line:

a) $FFV_{TOTAL} = FFV_A + FFV_B = \$400/ft + \$200/ft = 600$

b) Merge factor (MF) = Parcel depth/FFV_{TOTAL} = 180ft/600 = 0.30

c) Merge line_A = FFV_A x MF = \$400/ft x 0.30 = 120. This means that the merge line is located 120ft from Street A.

To check your result, you can calculate the merge line from the other street, using that front foot value:

Merge line_B = FFV_B x MF = \$200/ft x 0.30 = 60. This means that the merge line is located 60ft from Street B. Since 120ft + 60ft = 180ft = the total parcel depth, the merge line is correct.

Value of Lot A:

1) $DF = \sqrt{(\text{lot depth}/\text{standard depth})} = \sqrt{(120\text{ft}/100\text{ft})} = \sqrt{1.20} = 1.10$

2) $\text{Value}_A = FFV \times DF \times FF = \$400/\text{ft} \times 1.10 \times 50\text{ft} = \underline{\$22,000}$

Value of Lot B:

1) $DF = \sqrt{(\text{lot depth}/\text{standard depth})} = \sqrt{(60\text{ft}/100\text{ft})} = \sqrt{0.60} = 0.77$

2) $\text{Value}_B = FFV \times DF \times FF = \$200/\text{ft} \times 0.77 \times 50\text{ft} = \underline{\$7,700}$

Parcel Value = Lot Value_A + Lot Value_B = \$22,000 + \$7,700 = \$29,700

Calculate the parcel value for each of the properties below. Assume the street frontage is at the bottom of each diagram. Remember, calculate the merge line first, then use that to separate your parcel into two sections.

Problem 2.8.

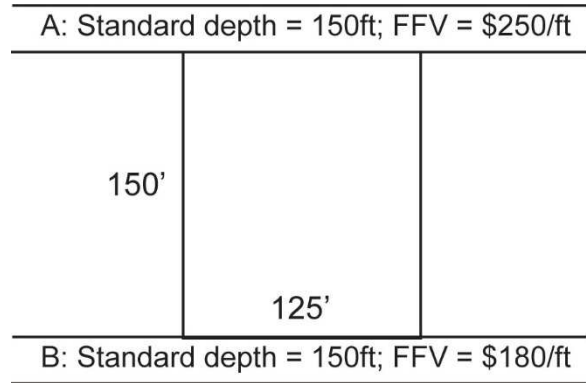

Problem 2.9.

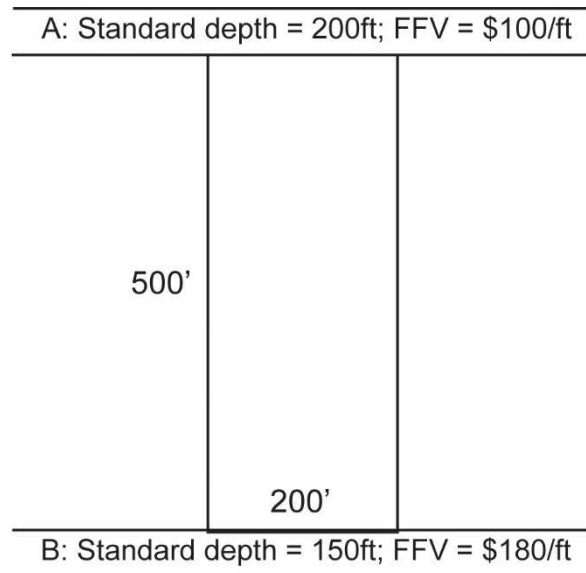

Problem 2.10.

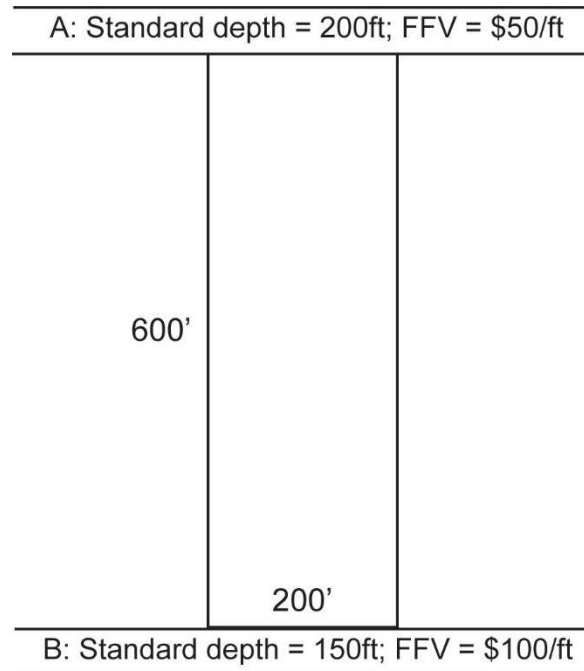

Problem 2.11.

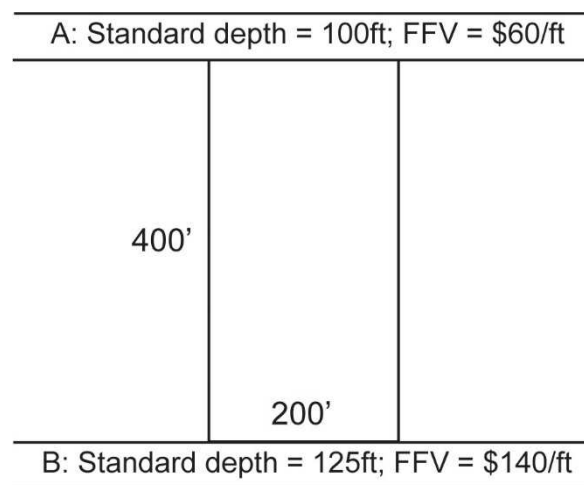

Value the Parcels Below, Using the Previous Methods

Problem 2.12.

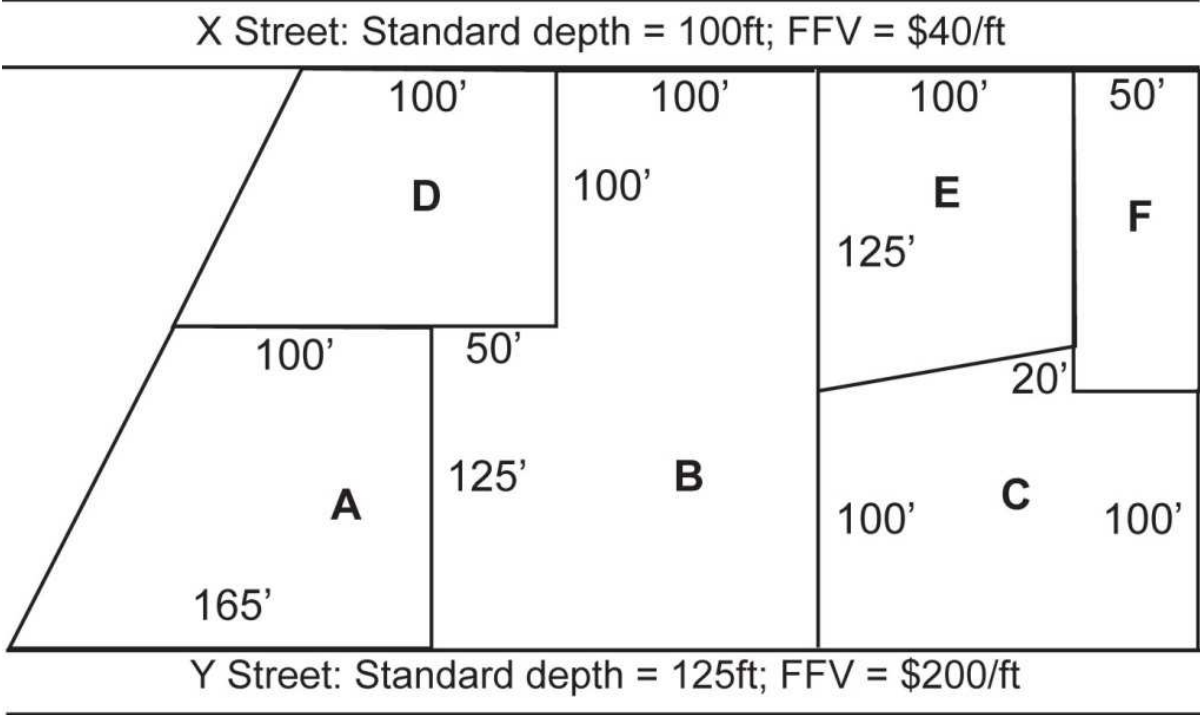

Problem 2.13.

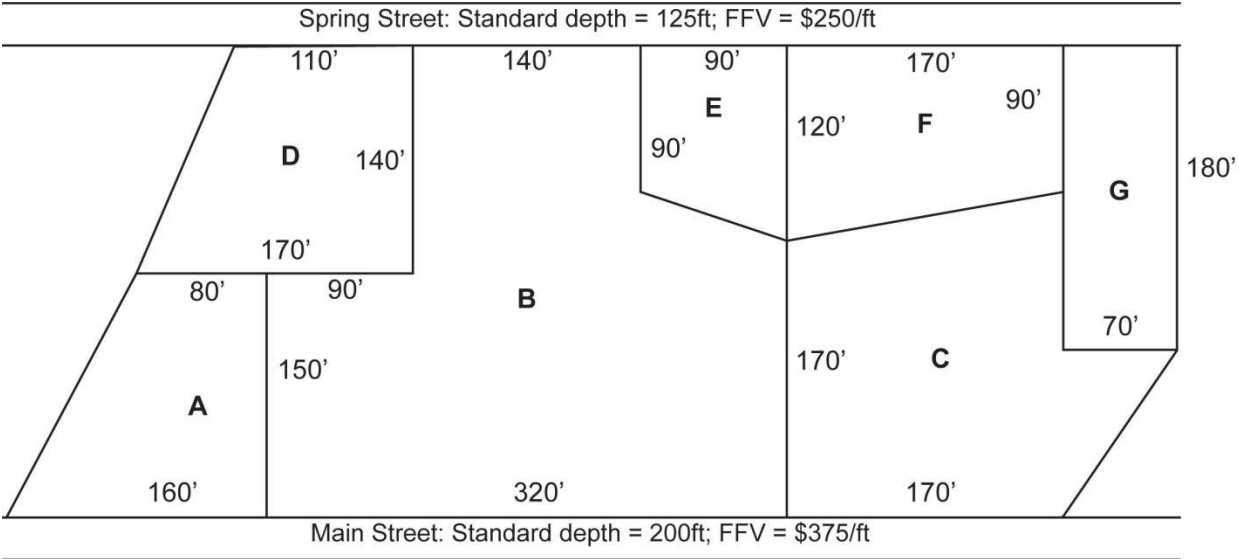

Square Foot Valuation

A property may be so valuable or of such size, it is sold in small increments. One square foot is 12 inches by 12 inches. For example, at \$2.00 per square foot, a 10,000-square-foot lot is valued at \$20,000.

$$10,000 \text{ sq. ft.} \times \$2.00/\text{sq.ft.} = \$20,000$$

Example. Suppose Parcel A from Problem 2.43 is valued at \$1.75/sq ft. Find the parcel value.

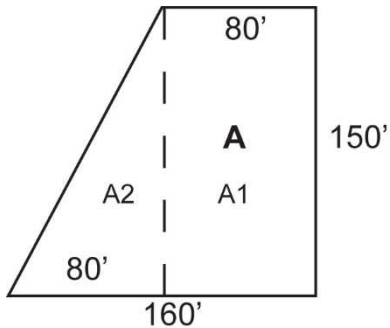

First, determine the area of the parcel:

$$\text{Area}_{A1} = \text{length} \times \text{width} = 80' \times 150' = 12,000 \text{ sq ft}$$

$$\begin{aligned} \text{Area}_{A2} &= \frac{1}{2} \times \text{length} \times \text{width} = \frac{1}{2} \times 80' \times 150' \\ &= 6,000 \text{ sq ft} \end{aligned}$$

$$\begin{aligned} \text{Area}_A &= \text{Area}_{A1} + \text{Area}_{A2} = 12,000 \text{ sq ft} + 6,000 \text{ sq ft} \\ &= 18,000 \text{ sq ft} \end{aligned}$$

Next, calculate the value:

$$\text{Value}_A = \text{Area}_A \times \text{sq ft value} = 18,000 \text{ sq ft} \times \$1.75/\text{sq ft} = \underline{\$31,500}$$

Problem 2.14. Find the value of the following parcel, if nearby land is selling for \$3.00/sq ft.

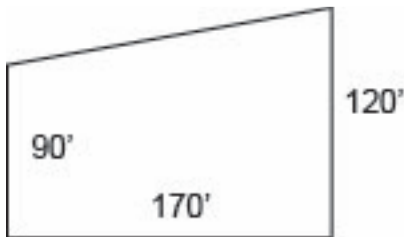

Front and Rear Acre Valuation

Sales of large parcels of land usually fall in this category. Parcels are sold per acre. Front acres, those closest to the road or waterfront, generally have higher value than rear acres. One acre is 43,560 square feet, or 208.71 ft x 208.71 ft. Usually the first acre of a sale will carry the bulk of the value. Other acres on the road/water will carry less value than the first acre, but more than the rear acres.

Example: 1 base unit acre at \$10,000, 6 front acres at \$2,000 each or \$12,000, plus 21 rear acres at \$1,000 or \$21,000, amounts to a total value of \$43,000.

Base	1 ac	x	\$10,000/ac	=	\$10,000
Front	+ 6	ac x	\$ 2,000/ac	=	\$12,000
Rear	+ 21 ac	x	\$ 1,000/ac	=	<u>\$21,000</u>
					<u>\$43,000</u>

Acreage calculations require the identification of a base acre value from local sales of single acres. Next, other sales of front acres are studied to determine front acre values. With known facts plus sales of rear acreage parcels, rear acreage value is isolated. The order of determination may differ depending on the jurisdiction, but the logic is the same. Identify similar land sales and determine values. Adjust each acre value (base, front, rear) based on volume and quality of similar area acreage sold. Parcels classified under a current use program (tree growth, farmland, open space, working waterfront) are considered invalid sales for this purpose.

Factors Affecting Land Value

Land value is affected by many different factors. Common land influences are:

- Location
- Corner influence
- Homogeneity of neighborhood
- Zoning
- Deed Restrictions
- Topography
- Excessive wetlands
- Ledge outcroppings
- Inharmonious influence
- Irregular shape
- Excessive area, depth or shallowness
- Easements
- Inharmonious influences (industrial, commercial, social and other)
- Development rights encumbrance

The quality of land also impacts the value of farmland. Common classifications of value and concern are:

- Tillable/productive
 - Cultivated
 - Orchard
 - Pasture
 - Wooded (where wood is harvested)
- Non-tillable or non-productive
 - Scrub land
 - Ledge or shale
 - Swamp, bog, or waste

Yield of tillable land is affected by soil texture, permeability, drainage, topography, and elevation/climate (early or late frost).

Common Land Classifications

Urban – developed & undeveloped

- residential
- commercial
- industrial

Rural - developed & undeveloped

- residential
- commercial
- industrial
- agricultural
 - a. unclassified
 - b. classified
 - 1) Tree Growth
 - 2) Farmland
 - 3) Open Space
 - 4) Working Waterfront

CHAPTER 3

MEASURING AND LISTING

One of the important jobs of an assessor is to record the details of each property in a municipality. This process is called measuring and listing. Measuring and listing requires a physical inspection of the property. Measuring means the actual measuring of buildings. Listing means the determination of the details of the property and the completion of a property record card for each parcel.

A property record card contains the property owner's name, mailing address, and contact information. The property record card also includes the property location, map and lot number, a sketch and/or a photograph of the property, and other information.

Measuring the Property

When approaching a building, look at the overall structure and consider the following questions.

- What obstacles or hazards are there to measuring this building – fences, holes, mud, thorn bushes, animals, electrical lines, septic systems malfunctioning, etc.? Is it safe to approach?
- Is the roofline straight? This may be an indicator of quality, depreciation, or obsolescence.
- How many stories?
- What is the roofing and siding material and condition?
- Is there a basement, and what is the foundation material?
- Is there an oil fill spout? This may indicate an oil-fired heating system.
- Where is the electrical entrance (the point where power lines enter the structure)?
- Are there additions to measure and inspect?
- Is there a pool or are there any outbuildings?

When visiting the property, knock on the door, introduce yourself, and show identification. Assessors do not have the right to enter private property. If the owner asks you leave, leave and make an estimate of the building and property characteristics from the street. Further, if the assessor feels that safety may be a concern, the assessor may opt to not enter that property.

Measuring begins on the outside of the property. Identify the story height of each portion of the building and determine the type of foundation and basement. Measure the building with this information in mind. Two-story sections must be separated from one-story sections in a sketch of the property. If the foundation or basement varies over the layout of the building, you must also note this on the property sketch. Measure each side of the building.

Make a rough sketch as you proceed around the building, measuring each different section. Note the length of each side, the height (number of stories), and the basement/foundation dimension associated with each section.

After measuring the outside of the building, inspect the interior, but only if the owner gives you permission. An interior inspection should start in the basement. A lot of helpful information can be found in the basement of a building. The following items affecting both grade and condition can be determined:

- Quality of stairs
- Foundation and basement material
- Basement ceiling height
- Finished basement area
- Water and other condition problems
- Type of heating system
- Quality of the flooring and wall framing (if exposed)
- Plumbing/piping quality
- Electrical rating and age
- Settling and framing issues

Sketching the Property

Sketching involves drawing an outline of each building, showing all major parts of the structure, such as decks and attached garages. Sketching requires several guidelines:

1. A straight-edge ruler or computer software should be used. Sketches should not be done free-hand.

Chapter 3 – Measuring and Listing

2. If software is not being used, exact scale is not necessary, but the assessor should get as close as possible to an accurate depiction.
3. Identify each section of a building.
4. Note all dimensions for each section.
5. Orient the sketch so that the street is at the bottom.

Suggested Abbreviations

Standardized abbreviations provide for consistent application of cost schedule data. It should be clear to everyone what is being priced. The following are some abbreviations found in the assessment field. Enter the appropriate designation on the part of the sketch represented. The square footage of the area is calculated and entered on the corresponding area and a circle drawn around the number.

Story Height	One story (1 St), One-and-a-half story (1 ½ St), Two story (2 St), etc.
Attic	A – finished (fin) or unfinished (unfin)
Basement	Full Basement (B) Concrete Slab (CS) Crawl Space (Cwl Sp) Daylight Basement (DB) with ¼, ½, ¾ included, if partial No Basement (NB)
Posts	Wood posts (WdP) Concrete posts or sonotubes (ConP)
Porches:	Open Porch (OP) Enclosed Porch (EP) Screened Porch (SP) Wood Deck (Plat)
Overhang	OH
Floors	Dirt (DF) Concrete (CF) Hardwood (HW) Softwood (SW)
Framing	Wood Frame (F) Brick (Br) Masonry (M) Garage
No Value item	NV
	GAR

Chapter 3 – Measuring and Listing

Example: A one-and-a-half story wood framed building on a one-half daylight basement and an unfinished attic would be designated:

1 ½ St/F/DB ½/A – unfin

A partial list of abbreviations is found in Chapter 5 of the Assessment Manual.

The following diagrams are two examples illustrating proper sketching procedures;

Sketch #1

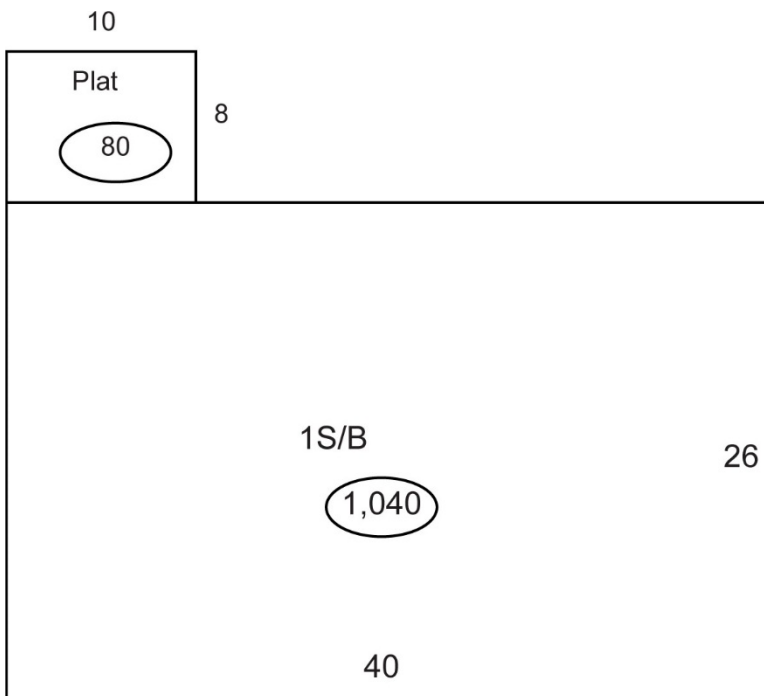

Sketch #2

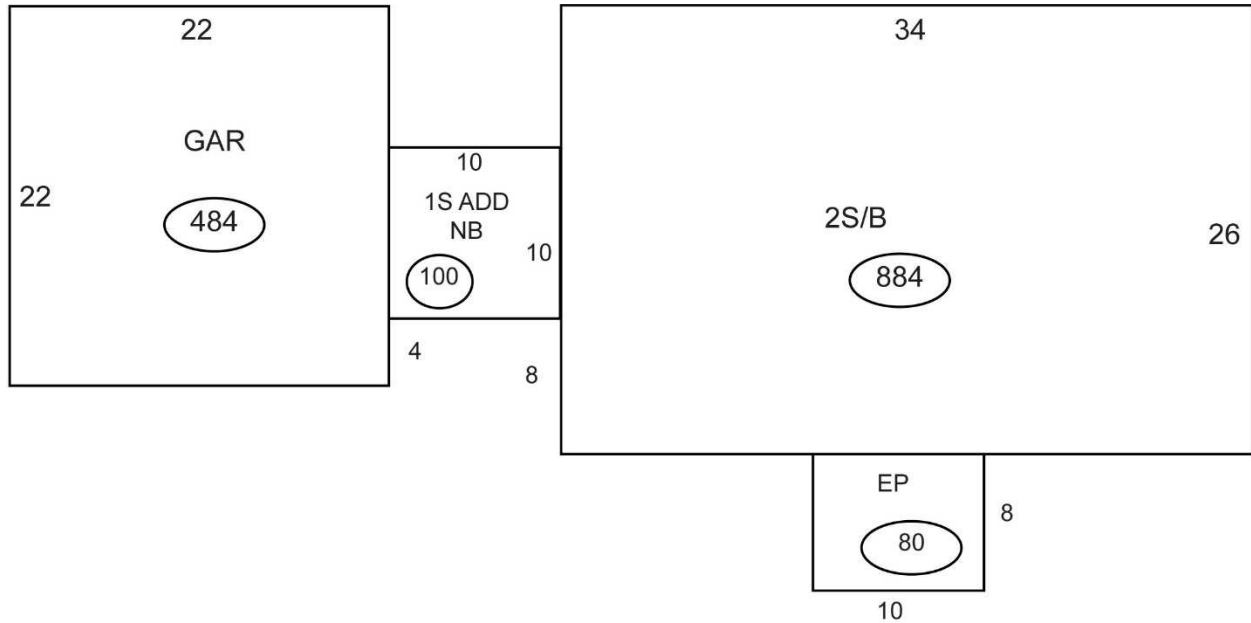

Class Problems

Answers on page 147

On separate paper, using a straight-edge, sketch the two buildings described below. Your sketches should be drawn to scale and centered on the page, within reason. Each building section should be labeled, dimensions should be included, and the square footage of each section shown.

Problem 3.1. A one-story ranch of wood frame construction on a full foundation with basement. The rear wall is 40 feet, the left side wall is 28 feet and the right-side wall is 24 feet. There is a front extension that is 4' x 12' and to the right of this is a 4' x 28' open porch. Attached to the right side of the house is a 24' x 24' garage. Attached to the back-right corner of the garage is a 12' x 12' wood deck (plat).

Problem 3.2. A one and three-quarter story cape style wood frame dwelling on a full foundation with basement. It measures 26' x 34', with 34' front and rear walls. Attached to the left side of the dwelling is a 12' x 14' one story addition on a foundation with a crawlspace. The 12' section runs along the left wall of the dwelling, beginning at the rear corner. Attached to the addition is a 12' x 14' shed on posts, with its 12' dimension running along, and even with, the left wall of the addition. Attached to the left side of the shed is a 28' x 36' barn with a loft, built on wood posts. The right front corner of the barn is even with the left front corner of the shed. The front of the barn is 28'.

Grading the Property

While you must adhere to the field manuals in use at your municipality, which may include different nuances, the following section discusses a standard grading system in use in Maine.

Ten Components of Structure

When valuing a building, assessors use ten basic components to determine grade. The components are:

1. Foundation
2. Basement
3. Framing
4. Roof
5. Interior
6. Exterior
7. Floors
8. Heating
9. Plumbing
10. Electrical

There are five grades applicable to buildings. They are:

Grade A (5). This grade usually applies to buildings that are architecturally designed, contractor built, with good materials and workmanship. A building of this grade has amenities, normally in the highest cost ranges.

Grade B (4). A building of this grade meets good building standard requirements with no architectural supervision. These buildings will ordinarily exceed standard building code requirements. Materials and workmanship are satisfactory and the building provides comfortable living space. Cost of construction and materials fall in the above average category.

Grade C (3). This grade of building will lack specialty design and ordinarily lack originality. This type of building will often be found in tract-style developments. A building of this grade usually meets, but doesn't exceed, building codes. Material and workmanship for these buildings are of production line quality. This type of building will fall in the average price range.

Grade D (2). A grade D building will be of substandard construction and usually lack modern facilities and equipment. This building will provide basic living space. Workmanship and materials for these buildings will be substandard compared to current building practices. Older homes will often fall in this grade.

Grade E (1). These structures are usually basic shelter but inadequate for residential living on a full-time basis. A building of this grade may be amateurishly constructed. The design, materials, and workmanship for these buildings are crude and rough. Summer camps will often fall in this category.

See the Assessment Manual Chapter 4 to review the specifications of the different grades. Become familiar with the requirements of each component for each grade of structure. Valuing a building requires the assessor to record and grade each component.

Class Problems

Answers on page 147

Example. See Grading Schedules, beginning on page 64.

The following is a sample grading calculation for a 1-story wood frame dwelling measuring 1,120 sq ft.

1. Foundation: **Grade: 3.6**

8' excavation – grade: 4; 8x18 footing – grade: 3; 8" poured concrete walls – grade: 3; drainage outside only – grade: 3; good site work – grade: 5.

Average grade = $(4 + 3 + 3 + 3 + 5)/5 = 3.6$

2. Basement: **Grade: 3.3**

7'0" depth – grade: 4; 6" gravel base and 3" concrete floor – grade: 3; no finished rooms – grade: 3.

Average grade = $(4 + 3 + 3)/3 = 3.3$

3. Framing: **Grade: 3.6**

2x10x16oc floor joists – grade: 4; 2x6x24oc studs – grade: 3; 2x6x16oc rafters – grade: 3; 2x8x16oc ceiling joists – grade: 4; 2x4x16oc interior partitions – grade: 4.

Average grade = $(4 + 3 + 3 + 4 + 4)/5 = 3.6$

4. Roof: **Grade: 3.3**

5/8 CDX plywood sheathing – grade: 3; 235lb asphalt cover – grade: 3; boxed cornice – grade: 4.

Average grade = $(3 + 3 + 4)/3 = 3.3$

5. Interior: **Grade: 3.8**
5/8 drywall – grade: 4; hw kitchen cabinets – grade: 4; sw trim – grade: 3;
panel doors – grade: 4; ample closets – grade: 4.

$$\text{Average grade} = (4 + 4 + 3 + 4 + 4)/5 = 3.6$$

6. Exterior: **Grade: 3.6**
5/8 CDX plywood – grade: 4; wood clapboards – grade: 3; builders grade DH
windows – grade: 3; 6" FG insulation – grade: 4; 2 exterior raised panel doors
& 2 storm doors – grade: 4.

$$\text{Average grade} = (4 + 3 + 3 + 4 + 4)/5 = 3.6$$

7. Floors: **Grade: 4.0**
½ plywood t&g boards – grade: 4; combination HW, tile & 32oz carpeting –
grade: 4.

$$\text{Average grade} = (4 + 4)/2 = 4.0$$

8. Heating: **Grade: 4.0**
Hot water radiant heat – grade: 4.

9. Plumbing: **Grade: 4.0**
3pc good fixtures – grade: 4.

10. Electrical: **Grade: 3.0**
100 amp panel – grade: 3; average fixtures and quality – grade: 3.

$$\text{Average grade} = (3 + 3)/2 = 3.0$$

$$\text{Total grade} = (3.6 + 3.3 + 3.6 + 3.3 + 3.8 + 3.6 + 4.0 + 4.0 + 4.0 + 3.0)/10 = 3.62$$

Total Grade (rounded): 3.6

Problem 3.3. The following is the description of a 1 ½ story wood frame dwelling with 960 SF on the main level. Calculate the grade of each component and the final total grade.

1. Foundation: **Grade:** _____
6'6" excavation – grade: _____; 8x18 footing – grade: _____; 8" poured concrete walls – grade: _____; outside drainage – grade: _____; waterproofed – grade: _____.

Average grade =

2. Basement: **Grade:** _____
6'6" depth – grade: _____; 6" gravel base and 3" concrete floor – grade: _____; no finished rooms – grade: _____.

Average grade =

3. Framing: **Grade:** _____
2x8x16oc floor joists – grade: _____; 2x6x16oc studs – grade: _____; 2x6x16oc rafters – grade: _____; 2x8x16oc ceiling joists – grade: _____; 2x4x24oc interior partitions – grade: _____.

Average grade =

4. Roof: **Grade:** _____
5/8 CDX plywood – grade: _____; 235lb asphalt cover – grade: _____; drip edge & boxed cornice – grade: _____.

Average grade =

5. Interior: **Grade:** _____
½ drywall – grade: _____; hardwood kitchen cabinets – grade: _____; softwood trim – grade: _____; interior panel doors – grade: _____; small closets – grade: _____.

Average grade =

6. Exterior: **Grade:** _____
5/8 CDX plywood – grade: _____; vinyl siding – grade: _____; builders grade DH windows – grade: _____, 6" insulation – grade: _____; 2 solid core exterior doors & 2 storm doors – grade: _____.

Average grade =

Chapter 3 – Measuring and Listing

7. Floors: **Grade:** _____
½ plywood – grade: _____; 32oz carpeting & linoleum – grade: _____.

Average grade =

8. Heating: **Grade:** _____
Forced hot air (with returns) – grade: _____.

9. Plumbing: **Grade:** _____
3pc average fixtures – grade: _____.

10. Electrical: **Grade:** _____
100 amp panel – grade: _____; average fixtures & quality – grade: _____.

Average grade =

Total grade =

Total Grade (rounded): _____

Problem 3.4 The following is the description of a 2-story wood frame dwelling with 884 SF on the main level. Calculate the grade of each component and the final total grade.

1. Foundation **Grade:** _____

8' excavation – grade: _____; 12x24 footing – grade: _____; 8" poured concrete walls, insulated and waterproofed – grade: _____; drainage on 2 sides – grade: _____; good site work – grade: _____.

Average grade =

2. Basement: **Grade:** _____

7'6" depth – grade: _____; 6" gravel base & 5" concrete floor smooth finish – grade: _____; finished rec room – grade: _____; built-in storage – grade: _____.

Average grade =

3. Framing: **Grade:** _____

2x12x16oc floor joists – grade: _____; 2x6x16oc studs – grade: _____; 2x10x16oc rafters – grade: _____; 2x8x16oc ceiling joists – grade: _____; 2x4x16oc interior partitions – grade: _____.

Average grade =

4. Roof: **Grade:** _____

T&G boards – grade: _____; wood shingles – grade: _____; drip edge & boxed cornice – grade: _____.

Average grade =

5. Interior: **Grade:** _____

5/8 drywall – grade: _____; hardwood kitchen cabinets – grade: _____; hardwood trim – grade: _____; raised panel interior doors – grade: _____; oak stairs – grade: _____; built-in cabinets – grade: _____.

Average grade =

6. Exterior: **Grade:** _____

5/8 CDX plywood – grade: _____; custom cedar shingles – grade: _____; good quality DH windows – grade: _____; 6" insulation – grade: _____; 2 exterior raised panel doors & 2 storm doors – grade: _____.

Average grade =

7. Floors: **Grade:**_____
¾ plywood – grade: _____; 32oz carpet & hardwood & tile – grade: _____.

Average grade =

8. Heating: **Grade:**_____
Hot water radiant.

9. Plumbing: **Grade:**_____
3pc good fixtures.

10. Electrical: **Grade:**_____
200 amp panel – grade: _____; recessed lighting – grade: _____; wired for data & cable – grade: _____.

Average grade =

Total grade =

Total Grade (rounded):_____

Chapter 3 – Measuring and Listing

Property Record Cards

Below is a sample property record card.

PROPERTY RECORD CARD						COUNTY
NAME	REMARKS	DATE	BOOK/PAGE	DATE	BOOK/PAGE	MAP NO. WASHINGTON
Taxpayer, Sample						PLAN NO.
						LOT NO.
						SUBD. LOT
						EXEMPT
						LEASE NO.
						LEASE FROM
Account # 00000001 Building 1 of 1	911 Road Name	Review date 08/09/2017 Review by ST ASSESSOR				
ADDRESS 123 FOURTH STREET BUÇOLICVILLE, MAINE Map A Plan B Lot C		Std Lot Size 1.0 acre	Std Depth	Avg Depth 0	Front Ft Price \$0	Parcel Acres 4.00
		Base Lot Type Devel Paved Rd	Base Lot 1.00	Unit Value \$8,400	Factor 1.00	Base Lot Value \$8,400
		Acreage	3.00	\$360		\$1,080
		Wet Land/Barren	0.00	\$90		\$0
		Topography			Adj	0.00
		Waterfront Front Feet	0	Depth Factor	Excess Factor	
		First 250 fr ft		0.00	0.00	\$0
		Next 300 fr ft	0	0.00	0.50	\$0
		550+ fr ft	0	0.00	0.35	\$0
		0.00 Waterfront Acres		0.00	Total Waterfront Value	\$0
		Topography				
		Lake Name				
		Other	Acres	\$/ac	Topography	
			0.00	0.00	0.00	0
			0.00	0.00	0.00	0
			0.00	0.00	0.00	0
		Paving	0	\$0	Well Type Dug	\$0
		GPS Coordinates			4.00ac. Unclassified	9,480
					Total Buildings:	70,240
					Tree Growth Valuation:	0
					Total Property:	79,720
					Tree Growth Acres:	0.00
					Total Acres:	4.00
					Date Printed 04/26/2018	

Chapter 3 – Measuring and Listing

CONSTRUCTION DETAILS				ADDS/DEDUCTS		Account # 291100091			
Foundation	3.00	Poured concrete 8"	No basement area	0	0	Miles, Roslie			
Basement	3.00	Full Avg Depth Conc Floor	Finished area	0	0	Stories	Grade	Area	Cost Rep
Framing	2.00	Old Style				1.5 story	2.60	720	46950
Roof	2.00	Boards Lightweight Asphalt Shingles				EP	3.00	240	8270
Interior	3.00	Drywall Softwood Trim Thermopane	Loft area	0	0				
Exterior	3.00	Boards Vinyl	Finished loft area	0	0				
Floors	2.00	Softwood Softwood Linoleum							
Heating	3.00	Forced Hot Air	No heat area	0	0				
Plumbing	2.00	2 Baths Inexpensive Fixtures Heater Pump			1830				
Lighting	3.00	Average	Other		0				
TOTAL	26.00	SURVEY BY	Total Adds & Deducts		1830				

GRADE	2.60
COND.	75 %

Story Height
 1st = One Story
 1.5st = 1(1/2) Story
 1.75st = 1(3/4) Story
 2st = 2 Story

FUNCTIONAL OBSOL %	ECONOMIC OBSOL %
0.00	Area 0.00
0.00	Access 0.00
	No Elec 0.00
TOTAL 0.00	Services 0.00
FACTOR 1.00	Topo 0.00
	TOTAL 0.00
	FACTOR 1.00

Current Cost Factor
 1.35

Yr	0	Mh		L	0	W	0		0
----	---	----	--	---	---	---	---	--	---

Building 1 of 1

Total Cost Rep	55220
Adjustment =	1830
Adjusted Cost Rep	57050
x Current Cost Factor	77020
Condition	0.75
Functional Factor	1.00
Economic Factor	1.00
Cost Rep Less Dep	57760
Plus Outbuildings	12480
TOTAL VALUE BUILDINGS	70240

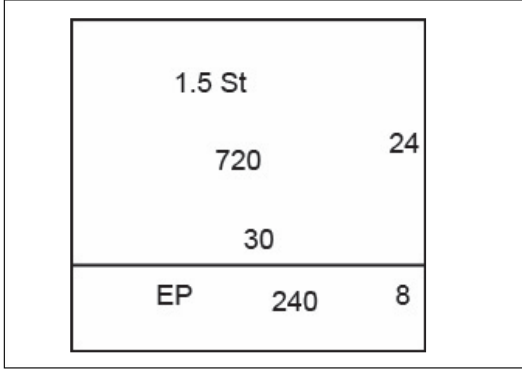

OUTBUILDING	Garage				
Floors	Concrete				
Foundation					
Ext. Walls	Vinyl				
Roof	Fiberglass				
Interior					
Wall-Height					
Electricity	Yes				
Other					
Other Cost	0.00				
TOTAL COST	14.90				
Size	30x40				
Area	1200				
COST OF REP	17880				
Unit Additions	2 OHD				
Unit Cost	1,080				
COST FACTOR	0				
Phys/Func/Ec%	0.65/0.75/1				
RCNLD	12480				

Grading Schedules

FOUNDATION

GRADE (1)	GRADE (2)	GRADE (3)	GRADE (4)	GRADE (5)
Clear and grub	Excavation 6'	Excavation 6' 6"	Excavation 8'	Excavation 8'+
Rough grade	Footing 8"x16"	Footing 8"x18"	Footing 12"x24"	Footing 12"x36"
Wood posts	Wall, rock	Wall, concrete block 7'	Wall, poured concrete 8"-10"	Wall, poured concrete 10"-12"
4"x12" girders	Wall, brick	Wall, poured concrete 8' 7'	Waterproofed	Waterproofed
Mudsills		Drainage outside	Insulation	Insulation
Rocks		Waterproofed	Drainage two sides	Drain tile two sides
			Site work, grade and clear	Site work, ample grade and clear

GRADE

Wood posts on concrete pads	1.5
Concrete posts (sonotubes)	2
Frost wall 8" poured concrete	3 Deduction for no basement
Frost wall concrete block	3 Deduction for no basement
Pressure treated wood walls	2

Chapter 3 – Measuring and Listing

BASEMENT

GRADE (1)	GRADE (2)	GRADE (3)	GRADE (4)	GRADE (5)
No basement	Depth 6' 0"	Depth 6' 6"	Depth: 7' 0"	Depth 7' 6"
	Dirt floor	6" gravel base floor	Gravel base 5", concrete floor	6" gravel base, 6" concrete floor
	3" concrete, rough	3" concrete floor, may not be smooth	Trowel finish, expansion joints	Trowel finish, expansion joints
			Wire fabric	Wire fabric
		No finished rooms	May have modest recreation room	May have finished recreation room
			Rough storage facilities	Fireplace, built in storage facilities

Chapter 3 – Measuring and Listing

FRAMING

GRADE (1)	GRADE (2)	GRADE (3)	GRADE (4)	GRADE (5)
	Below average material and workmanship	Average material and workmanship	Above average material and workmanship	Excellent materials and workmanship
Floor Joists: 2x6 24oc	Floor Joists: 2x6 16oc	Floor Joists: 2x8 16oc, 6½ composite 16oc	Floor Joists: 2x10 16oc, 11½ composite 16oc	Floor Joists: 2x12 16oc, 14composite 16oc, Steel I beams
Studs: 2x4 24oc	Studs: 2x4 24oc	Studs: 2x4 16oc, 2x6 24oc	Studs: 2x6 16 oc	Studs: 2x6 16 oc
Rafters: 2x4 24oc	Rafters: 2x4 20oc	Rafters: 2x6 16oc, truss 24 oc	Rafters: 2x8 16oc, truss 16 oc	Rafters: 2x10 16oc
Ceiling Joists: 2x6 24oc	Ceiling Joists: 2x4 16oc	Ceiling Joists: 2x8 16oc	Ceiling Joists: 2x8 16oc	Ceiling Joists: 2x8 16oc
Interior Partitions: None	Interior Partitions: 2x4 24oc	Interior Partitions: 2x4 24oc	Interior Partitions: 2x4 16oc	Interior Partitions: 2x6 16oc
Or: poles	Or: old style, camp style, round logs, vertical logs		Or: milled logs	

Chapter 3 – Measuring and Listing

ROOF

GRADE (1)	GRADE (2)	GRADE (3)	GRADE (4)	GRADE (5)
Sheathing: spaced boards	Sheathing: ½ CDX plywood, chipboard	Sheathing: 5/8 CDX plywood, chipboard	Sheathing: ¾ CDX plywood, T&G boards	Sheathing: ¾ CDX plywood, diagonal boards
Cover: roll paper	Cover: 210lb asphalt	Cover: 235lb asphalt	Cover: wood shingles, anodized metal	Cover: #1 wood shingles, assume hip roof or window slate dormers
Trim: drip edge	Trim: drip edge, raked cornice	Trim: drip edge, boxed cornice	Trim: drip edge, boxed cornice	Trim: drip edge, boxed cornice, copper gutters
Support: see framing	Support: see framing	Support: see framing	Support: see framing	Support: see framing

Chapter 3 – Measuring and Listing

INTERIOR

GRADE (1)	GRADE (2)	GRADE (3)	GRADE (4)	GRADE (5)
No interior finish	Minimum finish	Average finish and trim	Good quality finish and trim	Best quality finish and trim
	Old style lath and plaster	1/2 drywall	5/8 drywall or plaster	plaster walls and ceilings
No insulation	3/8 drywall, visible joints	Softwood kitchen cabinets 10lf	Hardwood kitchen cabinets 18lf	Marble countertops and sink
	Paneling	Softwood trim	Hardwood trim	Excellent hardwood trim
	Lower quality ceiling tile	Luan interior doors	Panel interior doors	Raised panel interior doors
	Minimum kitchen cabinets	Insulation	Ample closets	Oak stairs, custom treads and risers
	Minimum closets	Average ceiling tile or drywall		Built in cabinets
		Small closets		Walk in closets

Chapter 3 – Measuring and Listing

EXTERIOR

GRADE (1)	GRADE (2)	GRADE (3)	GRADE (4)	GRADE (5)
Sheathing: rough boards	Sheathing: chipboard 3/8 CDX ply, square edge bds	Sheathing: 1/2 CDX ply	Sheathing: 5/8 CDX ply, T&G boards	Sheathing: 3/4 CDX ply, T&G diagonal boards
Walls: mineral paper, asphalt shingles	Walls: hardboard T111, board and batten, novelty, rough log	Walls: vinyl 5/6 T111, aluminum, wood shingles, 2” milled logs, wood clapboards	Walls: custom cedar shingles, milled logs, custom wood clapboards	Walls: redwood clapboards, handsplit shakes, custom fenestration
Windows: few low quality	Windows: few, low quality	Windows: builders grade double hung	Windows: casement double hung	Windows: bow, casement double hung
Insulation: none	Insulation: building paper	Insulation: air infiltration wrap, fiberglass 3 1/2”	Insulation: air infiltration wrap, fiberglass 6”, foam board	Insulation: air infiltration wrap, fiberglass 6”+, foam board
Door: exterior door	Door: two exterior doors, solid core	Door: two exterior doors, raised panel, two storm doors	Door: two exterior doors, custom hardwood, solid core, two storm doors	Door: 2+ exterior doors, 2+ storm doors, atrium

Chapter 3 – Measuring and Listing

FLOORS

GRADE (1)	GRADE (2)	GRADE (3)	GRADE (4)	GRADE (5)
Substructure: see framing	Substructure: see framing	Substructure: see framing	Substructure: see framing	Substructure: see framing
Subfloor: none, single floor	Subfloor: 3/8 plywood	Subfloor: 1/2 plywood, boards not tight, underlayment 3/8	Subfloor: 1/2 plywood, T&G boards, underlayment 1/2	Subfloor: 3/4 plywood, T&G boards, diagonal underlayment 1/2
	Floor finish: softwood, 26oz carpeting, linoleum	Floor finish: padding, 32oz carpeting, linoleum, embossed matched softwood	Floor finish: padding, 32oz carpeting, hardwood tiles	Floor finish: padding, best carpeting, hardwood tiles, marble

HEATING

GRADE (1)	GRADE (2)	GRADE (3)	GRADE (4)	GRADE (5)
None	Gravity hot air (no returns), wall furnace, monitor electric	Forced hot air (with returns)	Hot water radiant	Hot water, multizoned central AC

PLUMBING

GRADE (1)	GRADE (2)	GRADE (3)	GRADE (4)	GRADE (5)
None	Three-piece inexpensive fixtures, sink, electric pump, water heater	Three-piece average fixtures, sink, electric pump, water heater	Three-piece good fixtures, sink, electric pump, water heater	Three-piece best fixtures, sink, electric pump, water heater

Chapter 3 – Measuring and Listing

ELECTRICAL

GRADE (1)	GRADE (2)	GRADE (3)	GRADE (4)	GRADE (5)
None	Minimum 60 amp service, few outlets, inexpensive fixtures	Average fixtures and quality, minimum code number of outlets, 100 amp panel	Good number of fixtures and quality, recessed lighting, 200 amp panel, 24 circuit	Best quality fixtures, numerous outlets, recessed lighting, 200 amp panel, 24 circuit
	wired for generator		wired for data and cable	wired for data and cable, security system

CHAPTER 4

THE COST APPROACH

The most popular and effective method of property valuation is the cost approach. This approach uses construction cost schedules. These schedules show an average cost of construction for buildings according to their size, quality of construction, type of structure, and structural details. If a subject property contains variations from the standard, such as three bathrooms instead of two, the assessor adjusts the cost estimate. Some of the variations affecting cost are heating, plumbing, lighting, extra facilities, porches, attachments, or structural improvements. Variations that are substandard decrease the cost estimate, while items that are better than standard increase the cost.

Cost schedules are presented in standard units of measure and are easily applied to a large variety of properties. Standard units of measure include cost per square foot or cost per cubic foot. Cubic foot measure is usually found in commercial or industrial cost manuals. Affecting these values are situations related to local market conditions, local requirements and construction practices.

Cost schedules include prices for additions, porches, additional plumbing, heating, and outbuildings such as garages, sheds, stables, barns, gazebos, decks, docks, boathouses, corrals, and studios. Any constructed property item in a municipality must be included in the cost schedules. Sample cost schedules are included in this chapter, starting on page 81.

Alternatives to Cost Schedules

One alternative to cost schedules is called the Contractor's or Quantity Survey Method. This involves a contractor or other knowledgeable individual making an estimate of the quantity of materials and labor necessary to construct the desired improvement. Typically, an itemized bill of materials is prepared, reflecting the cost of each type of material used together with labor charges for installation at the prevailing rates. A percentage rate is added for engineering and/or architect's fees, overhead costs, and contractor's profit. This method is both time consuming and expensive. It is accurate only if a trained person is developing the data. Furthermore, it is not feasible to perform such a study for each improved property within a typical jurisdiction. This method is often used in contractor bidding processes, rather than for mass appraisal.

Another alternative to cost schedules is referred to as the Unit-in-Place or Segregated Cost Method. This approach is useful if a special purpose facility is being assessed

and a traditional cost schedule approach cannot address the property's special features. The assessor estimates value based on a unit-in-place cost. It breaks down costs based on units of completed work. For example:

- Excavation – cost per cubic foot
- Foundation – cost per cubic yard of material and/or linear foot of wall
- Walls – cost per linear foot according to type of structure, such as brick, wood frame, and finishes

Manufactured Housing

Manufactured housing is built off-site in a climate-controlled environment, and transported to, and assembled on, the site. Two broad types of such housing are manufactured homes, commonly referred to as mobile homes, and modular homes. Mobile homes are built on a steel frame, which will remain in place when the unit is installed on the site. Mobile homes can be divided into two classes, HUD homes, and mobile homes. Mobile homes largely stopped being produced in 1976 and were built to different local codes. HUD homes were built after 1976 and are built to a nationwide HUD standard.

The valuation of modern mobile homes is approached similarly to site-built homes – estimates of value can be taken from the residential cost schedules. Older mobile homes (generally built prior to 1976) can be valued using a standardized mobile home valuation guide. This guide functions similarly to ordinary residential cost schedules with the exception of grade (a measure of quality), which is usually determined by brand name. Size of a mobile home is referenced by overall length and width. Costs of room additions, gravel or concrete pads, tie-downs, porches, garages, and other improvements are usually taken from the general cost schedule.

Modular homes are valued like site-built homes. If a steel frame remains under the structure, known as an on-frame modular, there may be a deduction in grade or an amount for functional obsolescence may be taken. The functional obsolescence results from the lack of certain secondary mortgage markets.

For more information, see State of Maine Assessment Manual, Chapter 8 – Mobile Homes.

Farm Properties

A farm property may appear to be a residence. A farm, however, is a commercial property and the farmer is a business operator. The family home of the farm is priced

like any other residence. Outbuildings may be of substantial value only to the extent that they contribute to the farming operation and their ability to generate income.

Many farms in Maine today are family farming operations that have expanded out of the necessity to stay competitive. Barns may contain hay or the family poultry flock, but do not ordinarily contribute significant value to the business. Most Maine farms are dairy operations, but some are commercial crop operations, and they are usually small and often organic in nature.

Farmland may qualify to be valued at a lower rate, through the Farm and Open Space Tax Law program. The farm owner must apply to be included in the program and the local assessor will value the land based on the value of other farmland in the area.

For more information, see Property Tax Bulletin No. 20 – Farmland Tax Law.

Commercial and Industrial Properties

Rarely will a municipality develop a specialized cost schedule to address commercial and industrial property valuation. This is especially true when reliable, commercial, proprietary cost manuals are both available and affordable. The Marshall & Swift manual is probably the most popular.

When using any manual other than the jurisdiction specific schedule, all valuations from these other manuals must be adjusted by the ratio of assessments to sales.

These types of manuals will often have generalized valuation sections. They will also require different adjustments than a residential cost schedule. For example, most commercial property schedules will require adjustment for the number of linear feet of perimeter wall in the form of a wall ratio or the relationship of building perimeter to floor area. The fact is the more a building departs from the square the more wall is required to enclose the space.

Example: A square building, $100' \times 100' = 10,000$ sq ft of area, has 400 linear feet of perimeter wall.

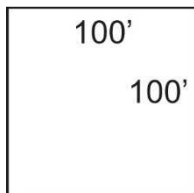

Each side is 100' long. Perimeter = $100' + 100' + 100' + 100' = 400'$

Alternately, a rectangular building with the same area, $50' \times 200' = 10,000$ sq ft has 500 linear feet of perimeter wall.

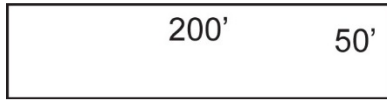

Two sides are 200' long and two sides are 50' long.
Perimeter = $200' + 50' + 200' + 50' = 500'$

Class Problem

Answer on page 152

Problem 4.1. Find the perimeter of this L-shaped building.

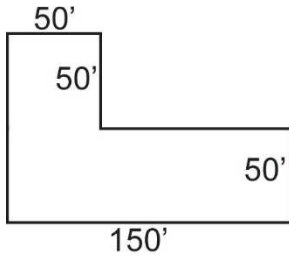

In addition to perimeter, wall height will affect cost. A wall 18' high will cost more in materials and labor than an 8' wall. The adjustments in commercial cost manuals usually take the form of a percentage increase from the base price.

Adjustments for perimeter and wall height generally do not appear in residential cost schedules. Residential property is usually built to similar standards (except for highly engineered or architecturally designed homes). This type of home will usually have a percentage of base value added to reflect the additional cost of professional design and supervision.

Steps in the Cost Approach

To determine the value of improvements under the cost approach, an assessor must perform three steps:

- 1) Establish the replacement cost of the buildings:
 - a. Measure and inspect the building;
 - b. Establish grades for the ten components of structure; and

Chapter 4 – The Cost Approach

- c. Determine the replacement cost from cost schedules, based on building size and grade.
- 2) Establish depreciation and subtract from replacement cost:
 - a. Physical deterioration;
 - b. Functional obsolescence; and
 - c. External obsolescence.
- 3) Determine land value

Land value is determined through a municipality’s land pricing schedules. Those pricing schedules are developed through analysis of land sales and other property sales with the improvement values removed. For purposes of this chapter, land values will be given.

Use of Cost Schedules

This text references the State of Maine Assessment Manual. This manual is used by Property Tax Division personnel in the valuation of property in the unorganized territory.

When valuing property using the cost method, an assessor must determine the quality of the structure being assessed. Quality is measured by **grade**, a category that is split into five levels. Grade level takes into consideration modern design standards and practices, construction methods, materials, and workmanship. The five grade levels are:

Grade 5 or A	Best construction
Grade 4 or B	Good construction
Grade 3 or C	Average or expected construction
Grade 2 or D	Below average construction
Grade 1 or E	Low cost or cheap construction

The grade of a building reflects only the quality of the building, the materials and workmanship, the level of detail, and quality of finish work. Cost varies with quality and any error or misjudgment in determining the quality of construction will adversely affect the final value estimate.

Grade is subject to continuing change, although it may be gradual. What may be or has been considered desirable or necessary to higher quality construction or design

might become neither desirable nor necessary with new developments and technology. Many buildings that an assessor may classify as Grade 3 or even 2 may have been Grade 5 when they were built. Quality will vary with changes in expectations, buying habits, and social traits of people. Quality must be measured through the eyes of the buyer in the market place.

Grade may vary according to location. It is subject to local preference and local conditions. For instance, light framing in roof construction in moderate climates is suitable for California. In Maine, however, a lightly framed roof is unacceptable due to heavy snow loads.

Most structures are a composite of items with different grades. A new building is easier to grade than an old building because all of the components that make up the new building are normally the same age and quality.

Once the grade is established, an assessor can determine the property's replacement cost from the appropriate cost schedule. Replacement cost is defined as the cost to replace a building using current construction methods and materials. Replacement cost differs from reproduction cost in that reproduction involves using the same construction methods and materials as in the existing structure.

The next step in valuing property using the cost method is to determine the **condition** of the property. Condition differs from grade in that condition relates to the value of a structure after wear and tear and obsolescence have been recognized. The assessing term for wear and tear is **depreciation**. A building with 25% depreciation is said to be in 75% condition (100% - 25%). The condition percentage applies whether the building was originally constructed with Grade 5 materials or Grade 3 materials. Grade is associated with construction, while condition is associated with destruction.

Example: You are assigned to value a 45-year-old single family ranch-style house. The aluminum siding is not only dated but pockmarked with dents and its color has faded. Roofing shingles are five years past due for replacement. Your analysis results in the following conclusion.

- Recent sales show that this type of structure depreciates at approximately one-half percent per year (45 years x 0.5% = 22.5% or 0.225) due to physical wear and tear.
- The replacement cost new (RCN) of this house is \$150,000.
- The remaining value, or replacement cost new less depreciation (RCNLD) of the building is:

Chapter 4 – The Cost Approach

$$\$150,000 - (\$150,000 \times 0.225) = \$150,000 - \$33,750 = \$116,250$$

$$\text{Condition} = 100\% - 22.5\% = 77.5\%$$

Functional obsolescence is defined as a decrease in value due to a change in demand, usually because of a shift in consumer tastes or of market standards. Functional obsolescence is calculated in the same way that depreciation is calculated. Functional obsolescence is calculated on the replacement cost new less depreciation. Suppose the house in the previous example has a basement with only six feet of head room and concrete walls that are six inches thick. These features, which may have been standard when the house was built, are substandard in today's market.

Municipal studies show that the functional obsolescence (FO) caused by these substandard features is 10% of value.

$$\text{RCNLD} = \$116,250$$

$$\text{RCNLD} - \text{FO} = \$116,250 - (\$116,250 \times 0.10) = \$116,250 - \$11,625 = \$104,625$$

Assessors must be careful not to apply both a grade reduction and functional obsolescence to the same feature. To explain the difference between reduction of grade and functional obsolescence, consider the following example. You are determining the value of a 1975 ranch house. The house was built with vinyl siding, three bedrooms and one bathroom. The vinyl siding, while still standard today, was of a lesser quality due to technological improvements in the manufacture of siding. The vinyl siding on the subject house would be subject to a reduction in grade. The single bathroom, due to a shift in consumer tastes, is now obsolete, with most new houses including two bathrooms. This feature would be subject to functional obsolescence.

External obsolescence (or economic obsolescence) is defined as a loss of value due to external factors. Examples of external obsolescence include the condition of other houses in the neighborhood and the presence of commercial property in an area that once was residential only. External obsolescence is calculated after depreciation and functional obsolescence.

In the above example, the assessor determined a 5% external obsolescence (EO) due to a retail store that was recently built down the street.

$$\text{RCNLD} - \text{FO} = \$104,625$$

$$\begin{aligned} \text{RCNLD} - \text{FO} - \text{EO} &= \$104,625 - (\$104,625 \times 0.05) \\ &= \$104,625 - \$5,231 = \$99,394, \text{ rounded to } \$99,400 \end{aligned}$$

The overall condition of the structure is $\$99,400/\$150,000 = 66.3\%$

A high-quality house, Grade 5, might be in the poorest condition of any house in town, and a Grade 1 house might be in the best condition. The value of a house is a combination of grade, depreciation, and obsolescence.

Current Cost Factor

The current cost factor is a periodic adjustment to the cost tables to reflect market fluctuations in construction costs over time. For example, if the cost schedules being used are ten years old, then the current cost factor adjusts the costs to reflect the changes over the last ten years. This cost factor is applied after replacement costs for all improvements have been estimated, and before depreciation is applied.

Garages and Outbuildings

Like other improvements, the cost schedules for garages and outbuildings reflect the value these items contribute to the whole property. Often, miscellaneous structures cost more than the value added to the property. Therefore, it is important, when assigning a value, that those values be viewed as the amount they contribute to the entire property, not just the cost to acquire and install.

Each outbuilding needs to be discovered and measured. This is the purpose in always walking entirely around a property during inspection. Story height and finish needs to be established, especially over an unfinished or partially finished garage. Condition must also be noted, in addition to the physical characteristics of the buildings, to make an estimate of value.

If pools, fencing, wood decking, or patios of block or concrete are items included in the inventory of improvements to be valued, their size and condition must also be noted.

**Cost Schedules
1 Story Dwelling**

Ground Area	Grade A(5)	Diff A-B	Grade B(4)	Diff B-C	Grade C(3)	Diff C-D	Grade D(2)	Diff D-E	Grade E(1)
300	95,880	32,370	63,510	19,500	44,010	13,190	30,820	15,060	15,760
320	99,850	33,590	66,260	20,350	45,910	13,650	32,260	15,660	16,600
340	103,820	34,810	69,010	21,190	47,820	14,130	33,690	16,250	17,440
360	107,800	36,040	71,760	22,040	49,720	14,590	35,130	16,850	18,280
380	111,770	37,260	74,510	22,880	51,630	15,070	36,560	17,440	19,120
400	115,740	38,480	77,260	23,730	53,530	15,530	38,000	18,040	19,960
420	119,810	39,790	80,020	24,580	55,440	16,000	39,440	18,620	20,820
440	123,880	41,090	82,790	25,430	57,360	16,480	40,880	19,200	21,680
460	127,950	42,400	85,550	26,280	59,270	16,960	42,310	19,770	22,540
480	132,020	43,700	88,320	27,130	61,190	17,440	43,750	20,350	23,400
500	136,090	45,010	91,080	27,980	63,100	17,910	45,190	20,930	24,260
520	139,530	45,840	93,690	28,880	64,810	18,260	46,550	21,650	24,900
540	142,970	46,670	96,300	29,780	66,520	18,610	47,910	22,360	25,550
560	146,420	47,520	98,900	30,670	68,230	18,960	49,270	23,080	26,190
580	149,860	48,350	101,510	31,570	69,940	19,310	50,630	23,790	26,840
600	153,300	49,180	104,120	32,470	71,650	19,660	51,990	24,510	27,480
620	157,420	50,400	107,020	33,290	73,730	20,160	53,570	25,090	28,480
640	161,540	51,620	109,920	34,110	75,810	20,660	55,150	25,670	29,480
660	165,660	52,830	112,830	34,930	77,900	21,180	56,720	26,250	30,470
680	169,780	54,050	115,730	35,750	79,980	21,680	58,300	26,830	31,470
700	173,900	55,270	118,630	36,570	82,060	22,180	59,880	27,410	32,470
720	177,080	56,220	120,860	37,320	83,540	22,550	60,990	27,880	33,110
740	180,260	57,170	123,090	38,070	85,020	22,930	62,090	28,350	33,740
760	183,450	58,120	125,330	38,840	86,490	23,290	63,200	28,820	34,380
780	186,630	59,070	127,560	39,590	87,970	23,670	64,300	29,290	35,010
800	189,810	60,020	129,790	40,340	89,450	24,040	65,410	29,760	35,650
820	193,230	61,140	132,090	41,040	91,050	24,370	66,680	30,390	36,290
840	196,650	62,260	134,390	41,730	92,660	24,710	67,950	31,030	36,920
860	200,080	63,390	136,690	42,430	94,260	25,030	69,230	31,670	37,560
880	203,500	64,510	138,990	43,120	95,870	25,370	70,500	32,310	38,190
900	206,920	65,630	141,290	43,820	97,470	25,700	71,770	32,940	38,830
920	210,100	66,600	143,500	44,520	98,980	26,040	72,940	33,420	39,520
940	213,290	67,570	145,720	45,220	100,500	26,390	74,110	33,900	40,210
960	216,470	68,540	147,930	45,920	102,010	26,720	75,290	34,400	40,890
980	219,660	69,510	150,150	46,620	103,530	27,070	76,460	34,880	41,580
1,000	222,840	70,480	152,360	47,320	105,040	27,410	77,630	35,360	42,270
1,020	226,250	71,640	154,610	48,130	106,480	27,700	78,780	35,860	42,920
1,040	229,660	72,800	156,860	48,940	107,920	27,990	79,930	36,360	43,570
1,060	233,070	73,970	159,100	49,730	109,370	28,290	81,080	36,850	44,230
1,080	236,480	75,130	161,350	50,540	110,810	28,580	82,230	37,350	44,880
1,100	239,890	76,290	163,600	51,350	112,250	28,870	83,380	37,850	45,530
1,120	242,860	77,210	165,650	51,920	113,730	29,250	84,480	38,380	46,100
1,140	245,830	78,120	167,710	52,490	115,220	29,630	85,590	38,930	46,660
1,160	248,800	79,040	169,760	53,060	116,700	30,010	86,690	39,460	47,230
1,180	251,770	79,950	171,820	53,630	118,190	30,390	87,800	40,010	47,790

Chapter 4 – The Cost Approach

1 Story Dwelling

Ground Area	Grade A(5)	Diff A-B	Grade B(4)	Diff B-C	Grade C(3)	Diff C-D	Grade D(2)	Diff D-E	Grade E(1)
1,200	254,740	80,870	173,870	54,200	119,670	30,770	88,900	40,540	48,360
1,220	257,930	81,670	176,260	55,030	121,230	31,120	90,110	41,080	49,030
1,240	261,120	82,470	178,650	55,870	122,780	31,450	91,330	41,620	49,710
1,260	264,300	83,250	181,050	56,710	124,340	31,800	92,540	42,160	50,380
1,280	267,490	84,050	183,440	57,550	125,890	32,130	93,760	42,700	51,060
1,300	270,680	84,850	185,830	58,380	127,450	32,480	94,970	43,240	51,730
1,320	273,520	85,710	187,810	59,000	128,810	32,800	96,010		
1,340	276,360	86,570	189,790	59,610	130,180	33,140	97,040		
1,360	279,190	87,410	191,780	60,240	131,540	33,460	98,080		
1,380	282,030	88,270	193,760	60,850	132,910	33,800	99,110		
1,400	284,870	89,130	195,740	61,470	134,270	34,120	100,150		
1,420	288,200	90,030	198,170	62,330	135,840	34,450	101,390		
1,440	291,540	90,940	200,600	63,190	137,410	34,780	102,630		
1,460	294,870	91,830	203,040	64,070	138,970	35,090	103,880		
1,480	298,210	92,740	205,470	64,930	140,540	35,420	105,120		
1,500	301,540	93,640	207,900	65,790	142,110	35,750	106,360		
1,520	304,540	94,790	209,750	66,300	143,450	36,080	107,370		
1,540	307,540	95,950	211,590	66,800	144,790	36,410	108,380		
1,560	310,530	97,090	213,440	67,320	146,120	36,720	109,400		
1,580	313,530	98,250	215,280	67,820	147,460	37,050	110,410		
1,600	316,530	99,400	217,130	68,330	148,800	37,380	111,420		
1,620	319,680	100,340	219,340	69,120	150,220	37,820	112,400		
1,640	322,840	101,290	221,550	69,910	151,640	38,260	113,380		
1,660	325,990	102,240	223,750	70,700	153,050	38,700	114,350		
1,680	329,150	103,190	225,960	71,490	154,470	39,140	115,330		
1,700	332,300	104,130	228,170	72,280	155,890	39,580	116,310		
1,720	335,290	104,820	230,470	73,250	157,220	39,700	117,520		
1,740	338,270	105,500	232,770	74,210	158,560	39,840	118,720		
1,760	341,260	106,190	235,070	75,180	159,890	39,960	119,930		
1,780	344,240	106,870	237,370	76,140	161,230	40,100	121,130		
1,800	347,230	107,560	239,670	77,110	162,560	40,220	122,340		
1,820	350,070	108,540	241,530	77,530	164,000	40,580	123,420		
1,840	352,910	109,520	243,390	77,950	165,440	40,940	124,500		
1,860	355,760	110,510	245,250	78,380	166,870	41,280	125,590		
1,880	358,600	111,490	247,110	78,800	168,310	41,640	126,670		
1,900	361,440	112,470	248,970	79,220	169,750	42,000	127,750		
1,920	364,370	113,070	251,300	80,080	171,220	42,380	128,840		
1,940	367,300	113,660	253,640	80,940	172,700	42,770	129,930		
1,960	370,240	114,270	255,970	81,800	174,170	43,150	131,020		
1,980	373,170	114,860	258,310	82,660	175,650	43,540	132,110		
2,000	376,100	115,460	260,640	83,520	177,120	43,920	133,200		
2,020	379,060	116,490	262,570	84,140	178,430	44,180	134,250		
2,040	382,020	117,510	264,510	84,770	179,740	44,430	135,310		
2,060	384,980	118,540	266,440	85,390	181,050	44,690	136,360		
2,080	387,940	119,560	268,380	86,020	182,360	44,940	137,420		
2,100	390,900	120,590	270,310	86,640	183,670	45,200	138,470		

Chapter 4 – The Cost Approach

1 1/2 Story Dwelling

Ground Area	Grade A(5)	Diff A-B	Grade B(4)	Diff B-C	Grade C(3)	Diff C-D	Grade D(2)	Diff D-E	Grade E(1)
300	112,550	33,590	78,960	26,070	52,890	15,010	37,880	18,350	19,530
320	117,450	34,930	82,520	27,160	55,360	15,630	39,730	19,110	20,620
340	122,350	36,270	86,080	28,240	57,840	16,260	41,580	19,870	21,710
360	127,250	37,600	89,650	29,340	60,310	16,890	43,420	20,620	22,800
380	132,150	38,940	93,210	30,420	62,790	17,520	45,270	21,380	23,890
400	137,050	40,280	96,770	31,510	65,260	18,140	47,120	22,140	24,980
420	142,320	41,810	100,510	32,780	67,730	18,690	49,040	23,120	25,920
440	147,590	43,340	104,250	34,060	70,190	19,230	50,960	24,100	26,860
460	152,850	44,870	107,980	35,320	72,660	19,790	52,870	25,080	27,790
480	158,120	46,400	111,720	36,600	75,120	20,330	54,790	26,060	28,730
500	163,390	47,930	115,460	37,870	77,590	20,880	56,710	27,040	29,670
520	167,810	49,000	118,810	38,950	79,860	21,390	58,470	27,890	30,580
540	172,230	50,070	122,160	40,030	82,130	21,900	60,230	28,740	31,490
560	176,640	51,120	125,520	41,130	84,390	22,390	62,000	29,600	32,400
580	181,060	52,190	128,870	42,210	86,660	22,900	63,760	30,450	33,310
600	185,480	53,260	132,220	43,290	88,930	23,410	65,520	31,300	34,220
620	190,530	54,590	135,940	44,460	91,480	24,010	67,470	32,240	35,230
640	195,580	55,920	139,660	45,630	94,030	24,610	69,420	33,170	36,250
660	200,620	57,240	143,380	46,790	96,590	25,210	71,380	34,120	37,260
680	205,670	58,570	147,100	47,960	99,140	25,810	73,330	35,050	38,280
700	210,720	59,900	150,820	49,130	101,690	26,410	75,280	35,990	39,290
720	214,570	60,650	153,920	50,320	103,600	26,830	76,770	36,660	40,110
740	218,430	61,410	157,020	51,520	105,500	27,240	78,260	37,340	40,920
760	222,280	62,150	160,130	52,720	107,410	27,670	79,740	38,000	41,740
780	226,140	62,910	163,230	53,920	109,310	28,080	81,230	38,680	42,550
800	229,990	63,660	166,330	55,110	111,220	28,500	82,720	39,350	43,370
820	234,410	64,990	169,420	56,040	113,380	29,060	84,320	40,070	44,250
840	238,830	66,330	172,500	56,960	115,540	29,620	85,920	40,790	45,130
860	243,250	67,660	175,590	57,880	117,710	30,180	87,530	41,520	46,010
880	247,670	69,000	178,670	58,800	119,870	30,740	89,130	42,240	46,890
900	252,090	70,330	181,760	59,730	122,030	31,300	90,730	42,960	47,770
920	256,110	71,400	184,710	60,760	123,950	31,690	92,260	43,650	48,610
940	260,140	72,480	187,660	61,790	125,870	32,080	93,790	44,350	49,440
960	264,160	73,540	190,620	62,840	127,780	32,450	95,330	45,050	50,280
980	268,190	74,620	193,570	63,870	129,700	32,840	96,860	45,750	51,110
1,000	272,210	75,690	196,520	64,900	131,620	33,230	98,390	46,440	51,950
1,020	276,370	76,840	199,530	66,000	133,530	33,540	99,990	47,180	52,810
1,040	280,530	77,990	202,540	67,090	135,450	33,850	101,600	47,940	53,660
1,060	284,700	79,160	205,540	68,180	137,360	34,160	103,200	48,680	54,520
1,080	288,860	80,310	208,550	69,270	139,280	34,470	104,810	49,440	55,370
1,100	293,020	81,460	211,560	70,370	141,190	34,780	106,410	50,180	56,230
1,120	296,720	82,240	214,480	71,430	143,050	35,220	107,830	50,840	56,990
1,140	300,420	83,030	217,390	72,480	144,910	35,660	109,250	51,510	57,740
1,160	304,130	83,820	220,310	73,550	146,760	36,080	110,680	52,180	58,500
1,180	307,830	84,610	223,220	74,600	148,620	36,520	112,100	52,850	59,250

Chapter 4 – The Cost Approach

1 1/2 Story Dwelling

Ground Area	Grade A(5)	Diff A-B	Grade B(4)	Diff B-C	Grade C(3)	Diff C-D	Grade D(2)	Diff D-E	Grade E(1)
1,200	311,530	85,390	226,140	75,660	150,480	36,960	113,520	53,510	60,010
1,220	315,650	86,480	229,170	76,600	152,570	37,480	115,090	54,230	60,860
1,240	319,760	87,560	232,200	77,540	154,660	37,990	116,670	54,960	61,710
1,260	323,880	88,660	235,220	78,480	156,740	38,500	118,240	55,680	62,560
1,280	327,990	89,740	238,250	79,420	158,830	39,010	119,820	56,410	63,410
1,300	332,110	90,830	241,280	80,360	160,920	39,530	121,390	57,130	64,260
1,320	335,820	91,610	244,210	81,470	162,740	39,910	122,830		
1,340	339,520	92,390	247,130	82,580	164,550	40,280	124,270		
1,360	343,230	93,170	250,060	83,690	166,370	40,660	125,710		
1,380	346,930	93,950	252,980	84,800	168,180	41,030	127,150		
1,400	350,640	94,730	255,910	85,910	170,000	41,410	128,590		
1,420	354,800	96,140	258,660	86,720	171,940	41,880	130,060		
1,440	358,960	97,550	261,410	87,530	173,880	42,340	131,540		
1,460	363,120	98,960	264,160	88,350	175,810	42,800	133,010		
1,480	367,280	100,370	266,910	89,160	177,750	43,260	134,490		
1,500	371,440	101,780	269,660	89,970	179,690	43,730	135,960		
1,520	375,080	102,470	272,610	91,110	181,500	44,140	137,360		
1,540	378,720	103,160	275,560	92,250	183,310	44,550	138,760		
1,560	382,350	103,840	278,510	93,400	185,110	44,950	140,160		
1,580	385,990	104,530	281,460	94,540	186,920	45,360	141,560		
1,600	389,630	105,220	284,410	95,680	188,730	45,770	142,960		
1,620	393,460	106,220	287,240	96,580	190,660	46,230	144,430		
1,640	397,290	107,220	290,070	97,470	192,600	46,700	145,900		
1,660	401,110	108,210	292,900	98,370	194,530	47,150	147,380		
1,680	404,940	109,210	295,730	99,260	196,470	47,620	148,850		
1,700	408,770	110,210	298,560	100,160	198,400	48,080	150,320		
1,720	412,810	111,260	301,550	101,120	200,430	48,570	151,860		
1,740	416,850	112,310	304,540	102,080	202,460	49,060	153,400		
1,760	420,890	113,370	307,520	103,030	204,490	49,560	154,930		
1,780	424,930	114,420	310,510	103,990	206,520	50,050	156,470		
1,800	428,970	115,470	313,500	104,950	208,550	50,540	158,010		
1,820	432,390	116,430	315,960	105,710	210,250	50,910	159,340		
1,840	435,800	117,380	318,420	106,480	211,940	51,270	160,670		
1,860	439,220	118,350	320,870	107,230	213,640	51,640	162,000		
1,880	442,630	119,300	323,330	108,000	215,330	52,000	163,330		
1,900	446,050	120,260	325,790	108,760	217,030	52,370	164,660		
1,920	450,020	121,300	328,720	109,690	219,030	52,850	166,180		
1,940	453,990	122,350	331,640	110,610	221,030	53,330	167,700		
1,960	457,960	123,390	334,570	111,550	223,020	53,810	169,210		
1,980	461,930	124,440	337,490	112,470	225,020	54,290	170,730		
2,000	465,900	125,480	340,420	113,400	227,020	54,770	172,250		
2,020	469,600	126,220	343,380	114,660	228,720	55,170	173,550		
2,040	473,310	126,970	346,340	115,930	230,410	55,560	174,850		
2,060	477,010	127,700	349,310	117,200	232,110	55,970	176,140		
2,080	480,720	128,450	352,270	118,470	233,800	56,360	177,440		
2,100	484,420	129,190	355,230	119,730	235,500	56,760	178,740		

Chapter 4 – The Cost Approach

1 3/4 Story Dwelling

Ground Area	Grade A(5)	Diff A-B	Grade B(4)	Diff B-C	Grade C(3)	Diff C-D	Grade D(2)	Diff D-E	Grade E(1)
300	124,170	36,190	87,980	28,850	59,130	16,520	42,610	19,180	23,430
320	128,260	35,980	92,280	30,410	61,870	17,110	44,760	20,460	24,300
340	132,360	35,770	96,590	31,990	64,600	17,700	46,900	21,720	25,180
360	136,450	35,560	100,890	33,550	67,340	18,290	49,050	23,000	26,050
380	140,560	35,360	105,200	35,130	70,070	18,880	51,190	24,260	26,930
400	144,650	35,150	109,500	36,690	72,810	19,470	53,340	25,540	27,800
420	149,030	35,340	113,690	38,060	75,630	20,130	55,500	26,530	28,970
440	153,410	35,520	117,890	39,440	78,450	20,780	57,670	27,530	30,140
460	157,800	35,720	122,080	40,820	81,260	21,430	59,830	28,510	31,320
480	162,180	35,900	126,280	42,200	84,080	22,080	62,000	29,510	32,490
500	166,560	36,090	130,470	43,570	86,900	22,740	64,160	30,500	33,660
520	171,050	36,670	134,380	44,850	89,530	23,380	66,150	31,450	34,700
540	175,530	37,230	138,300	46,150	92,150	24,010	68,140	32,400	35,740
560	180,020	37,810	142,210	47,430	94,780	24,650	70,130	33,350	36,780
580	184,490	38,360	146,130	48,730	97,400	25,280	72,120	34,300	37,820
600	188,990	38,950	150,040	50,010	100,030	25,920	74,110	35,250	38,860
620	193,320	38,940	154,380	51,400	102,980	26,600	76,380	36,370	40,010
640	197,640	38,930	158,710	52,780	105,930	27,280	78,650	37,490	41,160
660	201,980	38,930	163,050	54,180	108,870	27,960	80,910	38,610	42,300
680	206,300	38,920	167,380	55,560	111,820	28,640	83,180	39,730	43,450
700	210,640	38,920	171,720	56,950	114,770	29,320	85,450	40,850	44,600
720	215,290	40,040	175,250	58,180	117,070	29,870	87,200	41,740	45,460
740	219,940	41,160	178,780	59,410	119,370	30,420	88,950	42,630	46,320
760	224,580	42,260	182,320	60,640	121,680	30,970	90,710	43,540	47,170
780	229,230	43,380	185,850	61,870	123,980	31,520	92,460	44,430	48,030
800	233,880	44,500	189,380	63,100	126,280	32,070	94,210	45,320	48,890
820	238,330	45,260	193,070	64,500	128,570	32,460	96,110	46,360	49,750
840	242,780	46,020	196,760	65,910	130,850	32,840	98,010	47,400	50,610
860	247,240	46,780	200,460	67,320	133,140	33,240	99,900	48,440	51,460
880	251,690	47,540	204,150	68,730	135,420	33,620	101,800	49,480	52,320
900	256,150	48,310	207,840	70,130	137,710	34,010	103,700	50,520	53,180
920	260,220	49,020	211,200	71,190	140,010	34,650	105,360	51,520	53,840
940	264,290	49,730	214,560	72,260	142,300	35,280	107,020	52,520	54,500
960	268,340	50,410	217,930	73,330	144,600	35,910	108,690	53,530	55,160
980	272,410	51,120	221,290	74,400	146,890	36,540	110,350	54,530	55,820
1,000	276,480	51,830	224,650	75,460	149,190	37,180	112,010	55,530	56,480
1,020	281,470	53,150	228,320	76,770	151,550	37,740	113,810	56,310	57,500
1,040	286,460	54,480	231,980	78,060	153,920	38,300	115,620	57,090	58,530
1,060	291,440	55,790	235,650	79,370	156,280	38,860	117,420	57,870	59,550
1,080	296,430	57,120	239,310	80,660	158,650	39,420	119,230	58,650	60,580
1,100	301,420	58,440	242,980	81,970	161,010	39,980	121,030	59,430	61,600
1,120	305,510	59,450	246,060	82,970	163,090	40,340	122,750	60,350	62,400
1,140	309,580	60,430	249,150	83,980	165,170	40,690	124,480	61,280	63,200
1,160	313,670	61,440	252,230	84,990	167,240	41,040	126,200	62,190	64,010
1,180	317,740	62,420	255,320	86,000	169,320	41,390	127,930	63,120	64,810

Chapter 4 – The Cost Approach

1 3/4 Story Dwelling

Ground Area	Grade A(5)	Diff A-B	Grade B(4)	Diff B-C	Grade C(3)	Diff C-D	Grade D(2)	Diff D-E	Grade E(1)
1,200	321,830	63,430	258,400	87,000	171,400	41,750	129,650	64,040	65,610
1,220	326,050	63,960	262,090	88,330	173,760	42,440	131,320	64,870	66,450
1,240	330,280	64,490	265,790	89,670	176,120	43,120	133,000	65,710	67,290
1,260	334,480	65,000	269,480	91,000	178,480	43,810	134,670	66,540	68,130
1,280	338,710	65,530	273,180	92,340	180,840	44,490	136,350	67,380	68,970
1,300	342,930	66,060	276,870	93,670	183,200	45,180	138,020	68,210	69,810
1,320	347,390	67,460	279,930	94,660	185,270	45,510	139,760		
1,340	351,840	68,860	282,980	95,640	187,340	45,840	141,500		
1,360	356,310	70,270	286,040	96,640	189,400	46,160	143,240		
1,380	360,770	71,680	289,090	97,620	191,470	46,490	144,980		
1,400	365,220	73,070	292,150	98,610	193,540	46,820	146,720		
1,420	369,850	74,210	295,640	99,670	195,970	47,440	148,530		
1,440	374,460	75,330	299,130	100,730	198,400	48,060	150,340		
1,460	379,080	76,450	302,630	101,790	200,840	48,690	152,150		
1,480	383,690	77,570	306,120	102,850	203,270	49,310	153,960		
1,500	388,320	78,710	309,610	103,910	205,700	49,930	155,770		
1,520	392,120	79,150	312,970	105,030	207,940	50,590	157,350		
1,540	395,900	79,580	316,320	106,140	210,180	51,240	158,940		
1,560	399,710	80,030	319,680	107,270	212,410	51,890	160,520		
1,580	403,490	80,460	323,030	108,380	214,650	52,540	162,110		
1,600	407,290	80,900	326,390	109,500	216,890	53,200	163,690		
1,620	411,670	82,070	329,600	110,740	218,860	53,470	165,390		
1,640	416,030	83,210	332,820	111,980	220,840	53,750	167,090		
1,660	420,400	84,370	336,030	113,220	222,810	54,030	168,780		
1,680	424,760	85,510	339,250	114,460	224,790	54,310	170,480		
1,700	429,140	86,680	342,460	115,700	226,760	54,580	172,180		
1,720	433,320	87,470	345,850	116,790	229,060	55,280	173,780		
1,740	437,510	88,260	349,250	117,890	231,360	55,980	175,380		
1,760	441,700	89,060	352,640	118,970	233,670	56,700	176,970		
1,780	445,880	89,840	356,040	120,070	235,970	57,400	178,570		
1,800	450,070	90,640	359,430	121,160	238,270	58,100	180,170		
1,820	454,120	91,480	362,640	122,430	240,210	58,530	181,680		
1,840	458,150	92,290	365,860	123,700	242,160	58,960	183,200		
1,860	462,200	93,130	369,070	124,970	244,100	59,390	184,710		
1,880	466,230	93,940	372,290	126,240	246,050	59,820	186,230		
1,900	470,280	94,780	375,500	127,510	247,990	60,250	187,740		
1,920	474,410	95,570	378,840	128,810	250,030	60,390	189,640		
1,940	478,540	96,350	382,190	130,130	252,060	60,530	191,530		
1,960	482,650	97,120	385,530	131,430	254,100	60,670	193,430		
1,980	486,780	97,900	388,880	132,750	256,130	60,810	195,320		
2,000	490,910	98,690	392,220	134,050	258,170	60,950	197,220		
2,020	495,710	100,500	395,210	134,810	260,400	61,560	198,840		
2,040	500,510	102,310	398,200	135,560	262,640	62,180	200,460		
2,060	505,290	104,110	401,180	136,310	264,870	62,800	202,070		
2,080	510,090	105,920	404,170	137,060	267,110	63,420	203,690		
2,100	514,890	107,730	407,160	137,820	269,340	64,030	205,310		

2 Story Dwelling

Ground	Grade	Diff	Grade	Diff	Grade	Diff	Grade	Diff	Grade
	A(5)	A-B	B(4)	B-C	C(3)	C-D	D(2)	D-E	E(1)
300	134,050	28,380	105,670	41,530	64,140	13,420	50,720	25,770	24,950
320	140,130	29,570	110,560	43,360	67,200	13,990	53,210	26,990	26,220
340	146,200	30,750	115,450	45,180	70,270	14,570	55,700	28,210	27,490
360	152,280	31,940	120,340	47,010	73,330	15,130	58,200	29,450	28,750
380	158,350	33,120	125,230	48,830	76,400	15,710	60,690	30,670	30,020
400	164,430	34,310	130,120	50,660	79,460	16,280	63,180	31,890	31,290
420	170,890	36,290	134,600	51,930	82,670	17,230	65,440	32,820	32,620
440	177,350	38,270	139,080	53,200	85,880	18,180	67,700	33,750	33,950
460	183,810	40,240	143,570	54,470	89,100	19,150	69,950	34,680	35,270
480	190,270	42,220	148,050	55,740	92,310	20,100	72,210	35,610	36,600
500	196,730	44,200	152,530	57,010	95,520	21,050	74,470	36,540	37,930
520	202,420	45,670	156,750	58,350	98,400	21,850	76,550	37,450	39,100
540	208,110	47,140	160,970	59,690	101,280	22,650	78,630	38,370	40,260
560	213,800	48,600	165,200	61,050	104,150	23,440	80,710	39,280	41,430
580	219,490	50,070	169,420	62,390	107,030	24,240	82,790	40,200	42,590
600	225,180	51,540	173,640	63,730	109,910	25,040	84,870	41,110	43,760
620	231,510	53,270	178,240	65,130	113,110	25,920	87,190	42,140	45,050
640	237,840	55,000	182,840	66,530	116,310	26,790	89,520	43,180	46,340
660	244,160	56,720	187,440	67,920	119,520	27,680	91,840	44,220	47,620
680	250,490	58,450	192,040	69,320	122,720	28,550	94,170	45,260	48,910
700	256,820	60,180	196,640	70,720	125,920	29,430	96,490	46,290	50,200
720	261,890	61,200	200,690	72,130	128,560	30,010	98,550	47,250	51,300
740	266,950	62,220	204,730	73,520	131,210	30,590	100,620	48,230	52,390
760	272,020	63,240	208,780	74,930	133,850	31,170	102,680	49,190	53,490
780	277,080	64,260	212,820	76,320	136,500	31,750	104,750	50,170	54,580
800	282,150	65,280	216,870	77,730	139,140	32,330	106,810	51,130	55,680
820	287,480	66,200	221,280	79,500	141,780	32,740	109,040	52,190	56,850
840	292,800	67,110	225,690	81,280	144,410	33,140	111,270	53,240	58,030
860	298,130	68,030	230,100	83,050	147,050	33,560	113,490	54,290	59,200
880	303,450	68,940	234,510	84,830	149,680	33,960	115,720	55,340	60,380
900	308,780	69,860	238,920	86,600	152,320	34,370	117,950	56,400	61,550
920	313,940	70,720	243,220	88,390	154,830	34,790	120,040	57,380	62,660
940	319,090	71,570	247,520	90,170	157,350	35,220	122,130	58,370	63,760
960	324,250	72,430	251,820	91,960	159,860	35,630	124,230	59,360	64,870
980	329,400	73,280	256,120	93,740	162,380	36,060	126,320	60,350	65,970
1,000	334,560	74,140	260,420	95,530	164,890	36,480	128,410	61,330	67,080
1,020	339,860	75,190	264,670	97,170	167,500	36,920	130,580	62,360	68,220
1,040	345,160	76,230	268,930	98,830	170,100	37,340	132,760	63,390	69,370
1,060	350,450	77,270	273,180	100,470	172,710	37,780	134,930	64,420	70,510
1,080	355,750	78,310	277,440	102,130	175,310	38,200	137,110	65,450	71,660
1,100	361,050	79,360	281,690	103,770	177,920	38,640	139,280	66,480	72,800
1,120	366,880	80,360	285,520	105,330	180,190	38,940	141,250	67,410	73,840
1,140	370,710	81,360	289,350	106,890	182,460	39,230	143,230	68,350	74,880
1,160	375,540	82,350	293,190	108,450	184,740	39,540	145,200	69,280	75,920
1,180	380,370	83,350	297,020	110,010	187,010	39,830	147,180	70,220	76,960

2 Story Dwelling

Ground	Grade	Diff	Grade	Diff	Grade	Diff	Grade	Diff	Grade
	A(5)	A-B	B(4)	B-C	C(3)	C-D	D(2)	D-E	E(1)
1,200	385,200	84,350	300,850	111,570	189,280	40,130	149,150	71,150	78,000
1,220	390,170	84,760	305,410	113,330	192,080	40,760	151,320	72,180	79,140
1,240	395,140	85,180	309,960	115,090	194,870	41,380	153,490	73,210	80,280
1,260	400,120	85,600	314,520	116,850	197,670	42,000	155,670	74,240	81,430
1,280	405,090	86,020	319,070	118,610	200,460	42,620	157,840	75,270	82,570
1,300	410,060	86,430	323,630	120,370	203,260	43,250	160,010	76,300	83,710
1,320	414,840	87,310	327,530	122,040	205,490	43,500	161,990		
1,340	419,620	88,190	331,430	123,700	207,730	43,760	163,970		
1,360	424,390	89,060	335,330	125,370	209,960	44,020	165,940		
1,380	429,170	89,940	339,230	127,030	212,200	44,280	167,920		
1,400	433,950	90,820	343,130	128,700	214,430	44,530	169,900		
1,420	439,100	91,560	347,540	130,450	217,090	44,970	172,120		
1,440	444,260	92,310	351,950	132,200	219,750	45,400	174,350		
1,460	449,410	93,050	356,360	133,940	222,420	45,850	176,570		
1,480	454,570	93,800	360,770	135,690	225,080	46,280	178,800		
1,500	459,720	94,540	365,180	137,440	227,740	46,720	181,020		
1,520	464,470	95,420	369,050	139,080	229,970	46,950	183,020		
1,540	469,210	96,290	372,920	140,710	232,210	47,190	185,020		
1,560	473,960	97,160	376,800	142,360	234,440	47,430	187,010		
1,580	478,700	98,030	380,670	143,990	236,680	47,670	189,010		
1,600	483,450	98,910	384,540	145,630	238,910	47,900	191,010		
1,620	488,120	99,390	388,730	147,430	241,300	48,320	192,980		
1,640	492,780	99,860	392,920	149,240	243,680	48,730	194,950		
1,660	497,450	100,330	397,120	151,050	246,070	49,150	196,920		
1,680	502,110	100,800	401,310	152,860	248,450	49,560	198,890		
1,700	506,780	101,280	405,500	154,660	250,840	49,980	200,860		
1,720	511,660	102,230	409,430	156,030	253,400	50,350	203,050		
1,740	516,540	103,180	413,360	157,400	255,960	50,720	205,240		
1,760	521,410	104,130	417,280	158,750	258,530	51,100	207,430		
1,780	526,290	105,080	421,210	160,120	261,090	51,470	209,620		
1,800	531,170	106,030	425,140	161,490	263,650	51,840	211,810		
1,820	535,840	106,490	429,350	163,610	265,740	52,150	213,590		
1,840	540,500	106,940	433,560	165,740	267,820	52,440	215,380		
1,860	545,170	107,400	437,770	167,860	269,910	52,750	217,160		
1,880	549,830	107,850	441,980	169,990	271,990	53,040	218,950		
1,900	554,500	108,310	446,190	172,110	274,080	53,350	220,730		
1,920	559,270	108,740	450,530	173,630	276,900	53,990	222,910		
1,940	564,050	109,190	454,860	175,140	279,720	54,620	225,100		
1,960	568,820	109,620	459,200	176,650	282,550	55,270	227,280		
1,980	573,600	110,070	463,530	178,160	285,370	55,900	229,470		
2,000	578,370	110,500	467,870	179,680	288,190	56,540	231,650		
2,020	582,650	110,690	471,960	181,600	290,360	56,820	233,540		
2,040	586,930	110,870	476,060	183,520	292,540	57,110	235,430		
2,060	591,220	111,070	480,150	185,440	294,710	57,400	237,310		
2,080	595,500	111,250	484,250	187,360	296,890	57,690	239,200		
2,100	599,780	111,440	488,340	189,280	299,060	57,970	241,090		

Chapter 4 – The Cost Approach

Open Porch

	Grade	Grade	Grade	Grade	Grade
Area	Gr5	Gr4	Gr3	Gr2	Gr1
20	1,020	870	720	590	490
40	2,030	1,710	1,420	1,160	900
60	3,040	2,560	2,110	1,730	1,320
80	4,050	3,400	2,810	2,290	1,730
100	5,060	4,240	3,500	2,860	2,140
125	6,070	5,080	4,200	3,430	2,560
150	7,090	5,930	4,890	4,000	2,970
175	8,100	6,770	5,590	4,560	3,390
200	9,110	7,610	6,280	5,130	3,800
225	10,120	8,450	6,980	5,700	4,210
250	11,130	9,290	7,670	6,260	4,630
275	12,140	10,130	8,370	6,830	5,040
300	13,150	10,970	9,060	7,390	5,450
325	14,160	11,810	9,760	7,960	5,860
350	15,170	12,660	10,450	8,530	6,280
375	16,180	13,500	11,150	9,090	6,690
400	17,190	14,340	11,840	9,660	7,100
Over	43.00	35.85	29.60	24.15	17.75

Enclosed Porch

	Grade	Grade	Grade	Grade	Grade
Area	Gr5	Gr4	Gr3	Gr2	Gr1
20	3,710	2,980	1,970	1,500	1,270
40	5,920	4,620	3,140	2,320	1,970
60	8,130	6,270	4,300	3,140	2,670
80	10,330	7,910	5,470	3,960	3,370
100	12,540	9,550	6,630	4,780	4,070
125	14,750	11,190	7,800	5,600	4,770
150	16,950	12,840	8,960	6,430	5,480
175	19,160	14,480	10,130	7,250	6,180
200	21,360	16,120	11,290	8,070	6,880
225	23,570	17,760	12,460	8,890	7,580
250	25,780	19,410	13,620	9,710	8,280
275	27,980	21,050	14,790	10,530	8,980
300	30,190	22,690	15,950	11,350	9,680
325	32,400	24,330	17,120	12,170	10,380
350	34,600	25,980	18,280	12,990	11,080
375	36,810	27,620	19,450	13,810	11,780
400	39,010	29,260	20,610	14,630	12,480
Over	97.50	73.15	51.50	36.60	31.20

Chapter 4 – The Cost Approach

Deck

	Grade	Grade	Grade	Grade	Grade
Area	Gr5	Gr4	Gr3	Gr2	Gr1
20	960	870	740	670	590
40	1,560	1,380	1,190	1,070	920
60	2,090	1,880	1,650	1,460	1,250
80	2,660	2,390	2,100	1,860	1,580
100	3,220	2,890	2,550	2,250	1,910
125	3,790	3,400	3,010	2,650	2,240
150	4,360	3,900	3,460	3,040	2,570
175	4,920	4,410	3,920	3,440	2,900
200	5,490	4,910	4,370	3,830	3,230
225	6,060	5,410	4,820	4,220	3,560
250	6,620	5,920	5,280	4,620	3,890
275	7,190	6,420	5,730	5,010	4,220
300	7,750	6,920	6,180	5,400	4,550
325	8,320	7,430	6,630	5,800	4,880
350	8,880	7,930	7,090	6,190	5,210
375	9,450	8,440	7,540	6,590	5,540
400	10,010	8,940	7,990	6,980	5,870
Over	25.00	22.35	20.00	17.45	14.65

1 Story Addition

Ground	Grade	Diff	Grade	Diff	Grade
Area	A(5)	B(4)	C(3)	D(2)	E(1)
60	12,470	9,710	5,460	4,460	2,220
80	14,900	11,620	6,640	5,440	2,690
100	18,100	13,830	8,290	6,620	3,270
125	21,320	16,240	9,760	7,840	3,900
150	24,520	18,610	11,240	9,070	4,540
175	28,440	21,510	13,220	10,670	5,240
200	31,600	23,790	14,680	11,880	5,910
225	35,130	26,380	16,350	13,220	6,480
250	38,260	28,600	17,780	14,390	7,160
275	41,940	30,860	19,160	15,540	7,690
300	44,670	33,180	20,790	16,770	8,340
325	48,410	35,980	22,680	18,300	8,990
350	51,620	38,260	24,140	19,510	9,640
375	55,270	40,830	25,880	20,870	10,400
400	58,380	43,050	27,270	22,020	11,020
Over	145.95	107.60	68.20	55.05	27.55

Additions and Deductions (round to nearest overall grade)

Partial or No Basement Deduction

Deduct per sq ft of non-basement area

Grade 5	Grade 4	Grade 3	Grade 2	Grade 1
33.30	30.40	28.60	26.70	22.50

Finished Basement Rooms Addition

Add per sq ft of finished area

Grade 5	Grade 4	Grade 3	Grade 2	Grade 1
20.10	19.10	17.50	15.90	14.30

Finished Attic

Add per sq ft of finished area

Grade 5	Grade 4	Grade 3	Grade 2	Grade 1
31.30	27.30	22.60	17.80	15.40

Attic Sub Floor / Plywood

Add per sq ft of floor area

Grade 5	Grade 4	Grade 3	Grade 2	Grade 1
7.90	7.60	7.30	7.00	6.70

No Heat Deduction

Deduct per sq ft of unheated area

Grade 5	Grade 4	Grade 3	Grade 2	Grade 1
N/A	8.90	6.00	2.60	Included

Fireplace per unit

Masonry

Metal Pre Fabricated

Hearth

Grade 5	Grade 4	Grade 3	Grade 2	Grade 1
9,750	6,970	4,860	4,030	3,550
5,930	4,010	2,660	2,350	1,880
1,360	1,230	960	850	680

Plumbing Additions per unit

When more than three units are present

Grade 5	Grade 4	Grade 3	Grade 2	Grade 1
2,260	1,870	1,390	1,130	920

No Pump Deduction

Assume shallow well ½ hp pump and tank

1,900

Chapter 4 – The Cost Approach

Appliances	Range and Oven	1,100
	Microwave Combination	1,450
	Range Top	740
	Induction top	600
	Per component	680
	Ovens	1,200
	Microwave Combination	1,880
	Exhaust Fan	250
	Exhaust Fan and Hood	790
	Custom, stainless steel or copper	1,780
	Built-in Refrigerator or Freezer	2,880
	Dishwasher	760
	Garbage Disposal	480
	Trash Compactor	630
	Intercom	600
	Vacuum cleaner with 3 inlets	2,160
	Security System, hard wired	2,600

Roof Windows	Pitched without vent	460
	Pitched with vent	380
Brick / Stone Veneer	\$ per sq ft of wall area	7.00

Land Improvements

Drilled Well 3,800
 Assume 100ft deep well ¾ hp & tank

Septic System and Gravel Entrance 3,690
 Assume 1,000 gallon tank and leach field, typical gravel driveway

Paved Areas 2.80
 per sq ft up to 2000 sq ft

Chapter 4 – The Cost Approach

Outbuildings

Basic Specifications:

- Foundation** – Wood post, rocks or mudsills
- Framing** – 2x4 studs and plates, 2x6 rafters, 4x4 sills
- Walls** – Single board or 1/2" plywood, tar paper covered,
- Roof** – Asphalt roll roofing
- Floors** – None
- Interior** – No interior finish
- Heating** – None
- Lighting** – None
- Doors** – One common
- Windows** – Adequate

Cost per square foot

12.50

Additions to base cost per square foot

Floor	2"x6" joists plywood	5.30
	Concrete	4.00
	Dlb wood floor	6.90
Foundation	Concrete Posts	0.60
	4' Concrete Block	2.90
	Poured Concrete	3.00
Walls	T-111	5.30
	Hardboard	3.50
	Bd & Batt / Novelty	5.10
	Vinyl	5.20
	Aluminum	5.00
	Wood Shingles	8.20
	Wood Clapboards	7.80
Imitation log / 2" CS	8.20	
Overhead Doors per unit	Single	730
	Double	1,260
	Door Opener	510
Roof	Asphalt Shingles	1.80
	Metal	2.10
	Rubber Membrane	3.30
	Composite	2.60
	Wood Shingles	2.80

Chapter 4 – The Cost Approach

Interior	Plywood/Paneling	2.30
	Drywall	2.90
	Wood Boards	4.30
Electricity		0.70
Wall Height	8 foot	Standard
	10 foot	1.50
	12 foot	2.00
	14 foot	2.50
	16 foot	3.40
	18 foot	4.40

Depreciation and Condition

Condition is equal to the value of property after depreciation, divided by the property value before depreciation.

The International Association of Assessing Officers (IAAO) defines depreciation as:

“Loss in value of an object, relative to its replacement cost new, reproduction cost new, or original cost, whatever the cause of the loss in value. Depreciation is sometimes subdivided into three types: physical deterioration (wear and tear), functional obsolescence (suboptimal design in light of current technologies or tastes), and external obsolescence (poor location or radically diminished demand for the product).”

Depreciation for the assessor differs from that used for accounting purposes. Accounting depreciation is a method to spread out the cost of a capital expenditure over a period of time. Depreciation used in mass appraisal is determined by activity in the marketplace and is related to the market value of a property. Depreciation is the difference between replacement cost new and market value. This is also referred to “accrued depreciation”; it is the measure of the total value lost to depreciation.

The annual straight-line depreciation rate, for accounting purposes, is calculated by dividing 1 by the asset life of the building. For example, an industrial building has an asset life of 40 years. The annual straight-line depreciation rate is:

$$1/40 = 0.025 \text{ or } 2.5\%$$

If the building cost \$100,000 new, depreciation is equal to \$2,500 each year ($\$100,000 \times .025$). The book value of the building is the cost less accrued depreciation. After one year, the book value of the building is \$97,500 ($\$100,000 - \$2,500$). After two years, the book value is \$95,000 ($\$97,500 - \$2,500$). Accounting depreciation has no bearing on market value and is useful to assessors only when applying the income approach to value.

There are several methods of accounting depreciation used, but the most popular are straight-line depreciation and accelerated depreciation. Straight-line depreciation applies the same dollar amount of value reduction each year. Accelerated depreciation reduces value more in the early years than in later years.

Direct Method of Depreciation

The direct method of depreciation in the Maine Assessment Manual is called the breakdown method. The breakdown method estimates loss in value through inspection and observation of detailed structural components of property. This method applies the recognition, recording, and evaluation of specific causes of depreciation and their effect on value. Examples of specific causes of depreciation include wear and tear, age, and function within the building.

Modern mass appraisal techniques use a market modified method consistent with the cost approach and reflective of the direct method of depreciation. The loss of value is measured by physical wear and tear and other relevant factors and is correlated to the loss in value measured from the marketplace. Depreciation must be determined by observation, informed judgment, and study in each instance. The actual physical condition of the structure – as well as its relationship to other mutually comparable structures and locations – must be taken into consideration.

The accepted percentages of depreciation assigned should be commensurate with the condition of the property. Many cost schedules are designed so the percentage of depreciation falls within these ranges. The Maine Assessment Manual establishes these benchmark percentages as:

Excellent	10% (90% condition)
Good	20% (80% condition)
Average	30% (70% condition)
Fair	40% (60% condition)
Poor	50% (50% condition)
Unserviceable	> 50%, according to degree of deterioration

April 1 is the tax situs date in the state of Maine. Therefore, when considering depreciation of a structure or improvement, it should reflect the condition as of April

1. Only past events should be taken into consideration, not what will or may happen. If a building is scheduled to be demolished on April 2, that should not affect the valuation for April 1.

Physical Deterioration

Physical deterioration is the wearing out of a structure. It may be the result of wear and tear, use, or disuse. In many instances a structure will disintegrate or lose utility more rapidly as a result of disuse rather than use.

Physical deterioration is due, in part, to the action of the elements: rain, wind, hail, sun, shade, moisture, extreme dryness, storms, heat, cold, flood, decay, rot, etc. Disintegration from abuse is different from that of use or disuse. Other factors may come into play, such as infestations of carpenter ants, termites, or animals.

Finally, physical deterioration could in part result from poor construction. Exposed rafter ends, basements not waterproofed, and unfinished siding are examples of poor construction.

Functional Obsolescence

The IAAO defines functional obsolescence as a “[l]oss in value of a property resulting from changes in tastes, preferences, technical innovations, or market standards.” Functional obsolescence is the result of causes contained within the structure itself. A test to generally determine the presence of functional obsolescence is to ask if a similar structure built today would retain all of the general characteristics of the subject property, regarding design, size, materials, and facilities.

Functional obsolescence falls into several categories. These are:

Super-adequacy. A super-adequacy means the property contains a quality that is higher than current standards. Examples are:

- Too many rooms
- More facilities than needed
- Too large a structure, excessive square footage or area
- Ceilings too high
- High cost finish and trim
- Excessive built-ins not commensurate with home quality
- Expensive metals (gold faucets, brass balustrades etc.)

Inadequacy. An inadequacy means that the structure falls short of current market expectations. Examples are:

- Too small a structure
- Rooms too small
- Too few rooms
- Limited facilities
- Lack of storage area

Lack of Desirability. A lack of desirability means the property design is not in keeping with current standards. Examples are:

- Excessive ceiling heights
- Expansive halls, wasted space
- Strange shapes or situations (below ground, on stilts, domes, etc.)
- Design causing high maintenance cost
- Design with expensive items and little utility, carved wood trim and wainscoting, stained glass windows
- Antique or contemporary design out of step with market desire

Eccentric Design. An eccentric design is one departing from the accepted market standards as to construction/desirability. Examples are:

- Whimsy or unusual ideas of the builder
- Sunken living room

Atypical Layouts

- Poor layout/use of floor area
- Traffic flow undesirable (access to rest of home through a bedroom, etc.)
- Unusual shape or size resulting in unbalanced utility.

Outmoded equipment

- Bath rooms and plumbing (slate sinks, kitchen counters which are not waterproof)
- Electrical outlets (number and type, no GFI [ground fault indicator], fixtures)
- Heating (fireplaces as only heating system, no central heat, wood fired furnace only)

External Obsolescence

External obsolescence may be defined as a loss of value arising from causes external to the property. An owner has no control over this type of value loss, which can stem from an oversupply of equally desirable properties or from changes in character of neighboring properties. A neighborhood change could be one or more properties being rezoned for commercial or industrial development. The closer the rezoned property is to the subject property, the greater the loss of value. Another example of external obsolescence is a neighborhood's collective lack of attention to property maintenance over time.

Chapter 4 – The Cost Approach

It is possible for land to experience value loss due to external obsolescence. For example, if a low-grade house is built on high priced land it would depress the lot's value. This type of construction also affects nearby properties and can decrease those valuations.

The availability of services is a source of either external enhancement to, or detracting from, value. Public services usually enhance the value for properties in the average marketplace. These include:

- Water, sewer, and sanitation – trash and recyclable collection
- Public safety – police protection, fire protection and rescue availability
- Highway development and maintenance, snow removal
- Storm drainage
- Sidewalks
- Library
- Recreational opportunities
- Transportation to schools and businesses
- Education and cultural opportunities

Private services also enhance a property's worth, but may not increase it to the same degree as public services. Some private service considerations:

- Electricity
- Telephone
- Wireless communication availability
- Ability to access fuel for heat and other needs
- Gas
- Cable television, high-speed internet availability

Accessibility is another major factor affecting value. Value is influenced by the condition of roads leading to the subject property. The type of vehicle necessary to travel poorly maintained or unpaved roads can carry a high cost and can impact a homebuyer's decision. Lack of access will have less effect on seasonal property or extremely high valued property where privacy is the goal of the homebuyer.

Topography impacts property value. Land must provide the amenities expected according to the quality of the structures on it. An uneven lot detracts from desirability and thereby the value, of a quality home. A steep driveway makes access difficult and complicates snow removal. Side-hill lots sometimes require stairs, and steep grades may be difficult to negotiate with children, purchases, or physical challenges.

Most property record cards have areas designed for the recording of economic factors. They are under the general headings:

1. Neighborhood
2. Accessibility
3. Utilities
4. Services
5. Topography
6. Other

Summary

In review, depreciation consists of three separate and distinct aspects, each of which must be considered individually for its effect on the value of a property.

1. Physical deterioration is the disintegration or wasting away of a structure
2. Functional obsolescence is the lack of functionality inherent in a structure as compared with average market demands
3. External obsolescence is the effect of external factors on the value of property

Both physical deterioration and functional obsolescence have two common characteristics. They are restricted to causes originating within the structure itself and are said to be inherent or intrinsic aspects of depreciation. With either, there is the possibility the condition may be corrected or cured.

External obsolescence cannot be controlled or fixed by the owner of the property. It is said to be extrinsic, resulting from factors outside of the property itself. Often, it has a greater impact on value than other depreciation considerations.

See Maine Assessment Manual, Chapter 5, Residential Field Survey for a further discussion on depreciation and obsolescence.

Chapter 4 – The Cost Approach

Example. Calculate the value of the property described below. Your final value estimate should include the replacement cost of all improvements less depreciation and functional obsolescence.

The dwelling is a two-story colonial house built in 1950. It contains 3 bedrooms and 1 full bathroom. The house measures 26’x30’. The house has a finished attic, a masonry fireplace, an 80 sq ft open porch on the front and a 150 sq ft deck on the back. The property also includes a 484 sq ft detached garage. Details of the property inspection are included below.

All improvements are in average overall condition, with an estimated depreciation of 25%. There is functional obsolescence due to having only one bathroom, which is estimated at 5%. The property is in an established urban neighborhood consisting of similar aged homes with similar appeal. No external obsolescence is present.

See the cost schedules beginning on page 81 and the grade schedules from chapter 3.

Dwelling:

Following are the details of each of the ten components of structure.

<u>Component</u>	<u>Grade</u>
1. Foundation: 6’6” excavation; 8”x18” footing	3.0
2. Basement: 6’6” depth; 3” concrete floor; no finish	3.0
3. Framing: 2’x8’ 16oc floor joists; 2’x4’ 24oc partitions	3.0
4. Roof: 235lb asphalt cover; 3/4” plywood sheathing	3.5
5. Interior: 1/2” drywall; softwood kitchen cabinets.....	3.0
6. Exterior: wood shingles; builder’s grade double hung windows;.....	3.0
7. Floors: 32oz carpeting; hardwood tiles	4.0
8. Heating: hot water radiant.....	4.0
9. Plumbing: 3 piece average fixtures.....	3.0
10. Electrical: 100-amp panel; average fixtures.....	3.0

Total Grade (3+3+3+3.5+3+3+4+4+3+3)/10..... 3.3

A grade of 3.3 means we must interpolate the cost of the dwelling from the cost schedules. To do this, apply a two-step process. Step 1 is to multiply the difference between grade 3 and grade 4 for a 780-square-foot (26' x 30' = 780 sq ft), 2-story dwelling. From the cost schedules, we see that the difference between grade 3 and grade 4 (from the Diff B-C column) is \$25,040. Because 3.3 is 30% between grade 3 and grade 4 [(3.3 – 3.0)/(4.0 – 3.0)], multiply \$25,040 by 0.30, resulting in \$7,512. In Step 2, add the amount from Step 1 to the cost for grade 3 of the building (also from the cost schedule), \$70,160.

Dwelling:

Area = 26' x 30' = 780 sq ft	
Difference between grade 3 and grade 4:	\$ 76,320
Percent difference between grades 3 and 4 for the dwelling:	<u>x 0.30</u>
Cost difference:	\$ 22,896
Cost for 2-story, 780 sq ft dwelling, grade 3:	+ <u>\$136,500</u>
Total dwelling cost:	\$159,396

Additions and Deductions:

Finished attic, grade 3, cost per square foot:	\$ 22.60
Attic area in square feet (same as dwelling):	<u>x 780</u>
Attic cost:	\$ 17,628
Masonry fireplace, grade 3 cost:	+ <u>\$ 4,860</u>
Total additions and deductions cost:	\$ 22,488

Amenities:

Open Porch, 80 sq ft, grade 3:	\$ 2,810
Deck 150 sq ft, grade 3:	+ <u>\$ 3,460</u>
Total amenities cost:	\$ 6,270

Garage:

Base cost per square foot:	\$ 12.50
Poured concrete foundation cost per square foot:	+ \$ 3.00
Poured concrete floor cost per square foot:	+ \$ 4.00
Wood shingle walls cost per square foot:	+ \$ 8.20
Asphalt shingle roof cost per square foot:	+ \$ 1.80
Unfinished interior (included in base cost):	+ \$ 0.00
Electricity cost per square foot:	+ \$ 0.70
8-foot walls (included in base cost):	+ <u>\$ 0.00</u>
Total cost/sq ft:	\$ 30.20
Garage area, square feet:	<u>x 484</u>
Total garage cost:	\$ 14,617

Chapter 4 – The Cost Approach

Total property replacement cost new (RCN):	
Dwelling cost:	\$159,396
Additions and deductions cost:	\$ 22,488
Amenities cost:	\$ 6,270
Garage cost:	\$ 14,617
Total property RCN:	<u>\$202,771</u>

Depreciation:

RCN:	\$202,771
Depreciation percentage (25%)	x 0.25
Total depreciation	\$ 50,693

Functional obsolescence:

RCN:	\$202,771
Depreciation:	(\$ 50,693)
RCN less depreciation	\$152,078
Functional obsolescence percentage (5%):	<u>x 0.05</u>
Total functional obsolescence:	\$ 7,604

Total value of property:	
Total property RCN:	\$202,771
Total depreciation:	(\$ 50,693)
Total functional obsolescence:	<u>(\$ 7,604)</u>
Property value:	<u>\$144,474</u>

If rounded to the nearest \$1,000, the assessed value of this property would be \$144,000.

Class Problem

Answer on page 152

Problem 4.1. Calculate the value of the property described below. Your final value estimate should include the replacement cost of all improvements less depreciation and functional obsolescence.

The dwelling is a one-story ranch house measuring 30' x 40'. The assessor has given the house a grade of 3.5. The house has an enclosed porch measuring 25' x 6', also a grade 3.5. The house has a finished basement and a 350-square-foot paved driveway, each with a grade of 3.0. Included in the sale are a range and oven and a dishwasher, each a grade 3.0.

All improvements are in average overall condition, with an estimated depreciation of 20%. Functional obsolescence is estimated at 7%. No external obsolescence is present.

Chapter 4 – The Cost Approach

CHAPTER 5

THE MARKET APPROACH

The market approach is also known as the sales comparison approach. This approach is widely employed in assessment of residential properties. It is also used in the assessment of land, and limited commercial and multifamily properties. The principle of substitution is the basis of this approach to value.

The property to be valued is referred to as the subject property. Sold properties used as comparisons are called comparables. Sold properties may be comparable, but are rarely identical to the subject property. Therefore, to achieve an estimate of value for the subject, the selling prices of comparables must be adjusted. Adjustments are based on the differences between the subject and the comparable.

The adjustments to comparables are either additions or subtractions, based on differences with the subject property. When a comparable is more valuable than the subject, the selling price must be adjusted downward to reflect the lesser quality or quantity of the subject. When a comparable is less valuable than the subject, the selling price of the comparable must be adjusted upward to reflect the better quality or quantity of the subject. For example, if a comparable has three bedrooms and the subject has two bedrooms, the comparable sale price will most likely be adjusted downward, since a three-bedroom home is ordinarily more valuable than a two-bedroom home. This comparison and adjustment is done for each difference between the subject and the comparable.

The results of the adjustments provide a range of values for the subject. Generally, the sale with the fewest number of adjustments is the best indicator of value. However, if the soundness of the adjustment is less than desirable, a comparable with a larger adjustment may be a better indicator. For example, if the difference in sale prices between three-bedroom homes and two-bedroom homes fluctuates significantly in an area, but the difference between two-bedroom and four-bedroom homes is more consistent, an adjusted four-bedroom comparable may be a better value indicator for a two-bedroom home than an adjusted three-bedroom comparable. It is up to the assessor to decide the most reliable estimate.

An advantage of the market approach is the ease of understanding when presented to a taxpayer. It is reliable, especially when there are sufficient sales to be considered. The good judgment of the assessor is a vital component in the use of this approach. Adjustments to comparables must be based on studies of recent area sales.

There are disadvantages with the market approach. It may be difficult to verify sales data, no two properties are identical, and value differences are subjective

interpretations of market trends. Two condominiums in the same complex can have vastly different values if one faces north and has mountain views while another faces south and overlooks a parking lot. The age and physical condition of a property can substantially affect its value. Two houses can be alike structurally yet be subject to different levels of maintenance. The market approach is time-consuming, which poses a disadvantage for the assessor. However, it is a dependable method to use in defense of the cost approach and income approach information.

The market approach is a valuable tool in determining an estimate of value and is essential in the correlation of the three approaches to value.

Procedure

There are five basic steps in the application of the market approach:

1. Find recently sold property's that are similar to the subject (comparables).
2. Verify the information obtained about the comparables.
3. Select relevant units of comparison (for example, dollars per square foot).
4. Compare comparables to subject and adjust sale price of each comparable through a comparative market analysis. A comparative market analysis consists of three steps:
 - a. Identify the comparison characteristics.
 - b. Compare characteristics of comparables and subject property.
 - c. Adjust comparable values.
5. Reconcile the adjusted values of the comparables to determine a value estimate for the subject.

Comparative Market Analysis

Step 4 of the market approach procedure involves a comparative market analysis. In a comparative market analysis, a subject property is compared to sales of similar type properties. After making appropriate adjustments for differences in characteristics, the assessor determines the value of the subject property.

There are three basic steps in the comparative market analysis process:

1. Identify the comparison characteristics. Each comparison characteristic falls into one of four categories called elements of comparison:
 - a. Real property rights (fee simple, leased fee, etc.)
 - b. Market conditions (time adjustments, seller/buyer concessions, etc.)
 - c. Location (busy street vs. side street, etc.)
 - d. Physical characteristics (size, condition, number of rooms, etc.)
2. Compare the characteristics of each comparable with those of the subject property and make appropriate adjustments.
3. Derive a net adjustment for each comparable and apply it to its sale price to produce an adjusted value.

In a comparative market analysis, the comparable property – not the subject property – is adjusted. If a comparable has a superior characteristic, then a subtraction adjustment is made to the comparable. If a comparable has an inferior characteristic, an addition adjustment is made to the comparable.

A net adjustment for each comparable is calculated by summing the addition and subtraction adjustments. The net adjustment is then applied to the sale price of the comparable to produce an adjusted value.

Reconciliation of the adjusted values requires examination of the data to determine a value estimate for the subject. Ordinarily, the subject value estimate will be the adjusted value of the comparable with the smallest adjustment, provided the data doesn't point to a different conclusion. The subject property value estimate should not simply be the average of the adjusted values.

Step 4 of the analysis is to compare the characteristics of each comparable with those of the subject property and make appropriate adjustments. This step is accomplished through a grid showing the subject and comparable properties.

Each column in the grid represents the subject property or a comparable. Each row represents a comparison characteristic. The bottom rows list the number of adjustments, the net adjustments, and the adjusted sale prices.

Example. Comparative Market Analysis

Adjustments

- \$25/sf for building area difference
- \$1,500 for finished basement
- \$500 for deck
- \$5,000 for one-car detached garage

<u>Elements</u>	<u>Subject</u>	<u>Comp 1</u>	<u>Comp 2</u>	<u>Comp 3</u>
Sale Price	-----	\$199,000	\$206,000	\$210,000
Size	1,180sf	1,080sf	1,220sf	1,320sf
Adjustment	-----	\$2,500	(\$1,000)	(\$3,500)
Basement	Unfinished	Unfinished	Unfinished	Finished
Adjustment	-----	-----	-----	(\$1,500)
Deck	Deck	Deck	None	Deck
Adjustment	-----	-----	\$500	-----
Garage	None	None	None	one-car det
Adjustment	-----	-----	-----	(\$5,000)
# of Adjustments		1	2	3
Net Adjustment		+\$2,500	-\$500	-\$10,000
Adjusted Sale Price		\$201,500	\$205,500	\$200,000

Subject Value = \$201,500

Explanation: The subject value is equal to the adjusted sale price for Comparable #1, which had the fewest number of adjustments. The fact that the adjusted sale price for this comparable also fell in between the other two adjusted sale prices provided support for using that value estimate.

Class Problem

Answer on page 154

Problem 5.1. Comparative Market Analysis

Determine, using the data below and your own judgment, the value of the following subject property.

The subject property and all three comparables are located in the same area. All four properties are connected to public water and sewer and they all have typical sized parcels.

Subject: Located on a secondary street with typical appeal. The house is a 22 year old ranch, 1,040 square feet in area, with recent updates, and is in good condition. It has a full basement that is 50% finished. Amenities include an open porch in the front, a deck in back and a one-car garage.

Comparable 1: Sold for \$159,900, this house is located on a secondary street with typical appeal. The house is a 28 year old ranch, 960 square feet in area, in average condition. It has a full basement that is completely finished. Amenities include a deck in back.

Comparable 2: Sold for \$178,000, this house is located on a secondary street with typical appeal. The house is a 20 year old ranch, 1,144 square feet in area, with recent updates, and is in good condition. It has a full basement that is unfinished. Amenities include an enclosed porch in the front, a deck in back and a one-car garage.

Comparable 3: Sold for \$195,000, this house is located on a secondary street with better than average appeal. The house is a 20 year old ranch, 1,232 square feet in area, with recent updates and is in good condition. It has a full basement that is 25% finished. Amenities include an open porch in the front, a deck in back and a two-car garage.

Paired sales analyses have determined the following characteristic values.

- \$5,000 for a good location
- \$7,500 for an age/condition adjustment;
- \$35/sf for difference in area
- \$1,500 for a 25% finished basement
- \$3,000 for a 50% finished basement
- \$4,500 for a 75% finished basement
- \$6,000 for a fully finished basement
- \$4,000 for an enclosed porch
- \$2,500 for an open porch

Chapter 5 – The Market Approach

\$1,500 for a deck
\$5,000 for a one-car garage
\$9,000 for a two-car garage

Comparative Market Analysis

<u>Elements</u>	<u>Subject</u>	<u>Comp 1</u>	<u>Comp 2</u>	<u>Comp 3</u>
-----------------	----------------	---------------	---------------	---------------

Sale Price

Location/site
Adjustment

Age/condition
Adjustment

Size
Adjustment

Basement
Adjustment

Deck
Adjustment

Garage
Adjustment

of Adjustments

Net Adjustment

Adjusted Sale Price

Subject Value =

Explanation:

Paired Sales Analysis

But how are the adjustments for each characteristic calculated? The value of separate characteristics is determined through a paired sales analysis.

Step 1 of the comparative market analysis is to identify the comparison characteristics. Once the characteristics are identified, the assessor must determine the adjustment amount – or value – for each characteristic. The best way to estimate characteristic value is to perform a paired sales analysis, which involves comparing two properties that are similar, with the exception of one characteristic.

Example. You have found three recent single-family home sales in the same neighborhood with similar style, size, age, quality, and amenities except one of the properties has a garage. To calculate the value of the garage, compare the sale prices of the three properties.

Sale 1(with garage) sale price =	\$172,000
Sale 2 (without garage) sale price =	<u>\$159,500</u>
Indicated value of garage =	\$ 12,500

Sale 1(with garage) sale price =	\$172,000
Sale 3 (without garage) sale price =	<u>\$158,000</u>
Indicated value of garage =	\$ 14,000

By performing these two paired sales comparisons we can reasonably conclude that the market value of the garage is between \$12,500 and \$14,000.

Example: Suppose you have the following six sales. First you want to determine the value of each of the following characteristics: 1) Condition of improvement; 2) Site shape; 3) Garage; 4) View; and 5) Access. To conduct a paired sales analysis, follow these steps:

- Step 1: On a grid, note the differences between sales and the subject.
- Step 2: Find a set of comparables that differ in only one respect.
- Step 3: Using the paired sales determine whether the presence of the feature is a positive or negative, and the value of the adjustment
- Step 4: Enter in the grid an adjustment for each comparable that has this difference.
- Step 5: Repeat steps 2, 3, and 4 until all differences are accounted for.

Chapter 5 – The Market Approach

Step 1. Below is the grid showing differences between sales and the subject.

	Subject	Sale 1	Sale 2	Sale 3	Sale 4	Sale 5	Sale 6
Price	?	\$105,000	\$101,000	\$96,000	\$109,800	\$103,000	\$103,800
Cond of Improv	Good	Good (Same)	Poor	Poor	Good (Same)	Good (Same)	Poor
Adjusted Price							
Site shape	Irreg	Reg.	Reg.	Irreg. (Same)	Irreg. (Same)	Reg.	Irreg. (Same)
Adjusted price							
Garage	1 car	2 Car	1 Car (Same)	1 Car (Same)	2 Car	1 Car (Same)	2 Car
Adjusted Price							
View	Yes	No	Yes (Same)	No	Yes (Same)	No	Yes (Same)
Adjusted Price							
Access	Poor	Poor (Same)	Poor (Same)	Poor (Same)	Good	Poor (Same)	Good
Adjusted Price							
Price after adj.							

Chapter 5 – The Market Approach

Step 2. Note that Sale 4 and Sale 6 differ in only one characteristic, condition of improvement.

Step 3. Compare the sale prices of Sale 4 and Sale 6. The difference is attributable to the difference in condition (good vs poor). In this case, we want a positive adjustment of \$6,000 to comparable properties with poor condition.

Step 4. Enter the adjustments to Sales 2, 3, and 6 in the grid below.

	Subject	Sale 1	Sale 2	Sale 3	Sale 4	Sale 5	Sale 6
Price	?	\$105,000	\$101,000	\$96,000	\$109,800	\$103,000	\$103,800
Cond of Improv	Good	Good (Same)	Poor	Poor	Good (Same)	Good (Same)	Poor
Adjusted Price			+\$6,000 \$107,000	+\$6,000 \$102,000			+\$6,000 \$109,800
Site shape	Irreg	Reg.	Reg.	Irreg. (Same)	Irreg. (Same)	Reg.	Irreg. (Same)
Adjusted price							
Garage	1 car	2 Car	1 Car (Same)	1 Car (Same)	2 Car	1 Car (Same)	2 Car
Adjusted Price							
View	Yes	No	Yes (Same)	No	Yes (Same)	No	Yes (Same)
Adjusted Price							
Access	Poor	Poor (Same)	Poor (Same)	Poor (Same)	Good	Poor (Same)	Good
Adjusted Price							
Price after adj.							

Chapter 5 – The Market Approach

Step 5. Repeat steps 1 through 4 for all the other characteristics, entering the adjustments in the grid. The bottom row shows all comparable sales adjusted for the differences between the sale and the subject.

	Subject	Sale 1	Sale 2	Sale 3	Sale 4	Sale 5	Sale 6
Price	?	\$105,000	\$101,000	\$96,000	\$109,800	\$103,000	\$103,800
Cond of Improv	Good	Good (Same)	Poor	Poor	Good (Same)	Good (Same)	Poor
Adjusted Price			+\$6,000 \$107,000	+\$6,000 \$102,000			+\$6,000 \$109,800
Site shape	Irreg	Reg.	Reg.	Irreg. (Same)	Irreg. (Same)	Reg.	Irreg. (Same)
Adjusted price		-\$1,000 \$104,000	-\$1,000 \$106,000			-\$1,000 \$102,000	
Garage	1 car	2 Car	1 Car (Same)	1 Car (Same)	2 Car	1 Car (Same)	2 Car
Adjusted Price		-\$2,000 \$102,000			-\$2,000 \$107,800		-\$2,000 \$107,600
View	Yes	No	Yes (Same)	No	Yes (Same)	No	Yes (Same)
Adjusted Price		+\$4,000 \$106,000		+\$4,000 \$106,000		+\$4,000 \$106,000	
Access	Poor	Poor (Same)	Poor (Same)	Poor (Same)	Good	Poor (Same)	Good
Adjusted Price					-\$1,800 \$106,000		-\$1,800 \$106,000
Price after adj.		\$106,000	\$106,000	\$106,000	\$106,000	\$106,000	\$106,000

As you can see in this example, each sale adjusts perfectly to the price of \$106,000. This is the value we now place on the subject property. In practice, adjusted comparable prices won't result in such a clear indicator of price, but using an adequate number of comparable sales should give you a pretty good idea of the value of the subject property.

Class Problem

Answer on page 154

Problem 5.2. Paired Sales Analysis. Using the grid below, apply the paired sales analysis steps to adjust comparables to the subject property. What assessed value would you give to the subject property?

Hint: Compare Sales 2 & 5 for the deck, 1 & 5 for the garage, and 1 & 4 for the basement.

	Subject	Sale 1	Sale 2	Sale 3	Sale 4	Sale 5
Price	?	\$195,000	\$210,000	\$185,000	\$180,000	\$205,000
Deck	Yes	No	Yes	Yes	No	No
Adjusted Price						
Garage	1-car	1-car	2-car	1-car	1-car	2-car
Adjusted price						
Basement	Full	Full	Full	Partial	Partial	Full
Adjusted Price						
Price after adj.						

CHAPTER 6

THE INCOME APPROACH

The income approach creates a value estimate for income-producing property based on the anticipated income from that property. The income approach is sometimes referred to as the income capitalization approach, since the calculated value is the result of the application of a capitalization rate to estimated future income. The capitalization rate converts the future income to a present value.

The basic formula for the income approach is: $I = R \times V$, where I = Income, R = Rate, and V = Value. Income is an estimate of future net operating income for the property. Rate is the capitalization rate – or cap rate - for short.

Example. What is the value of a motel with \$60,000 of income and a capitalization rate of 12%?

$$\begin{aligned} I &= R \times V \\ \$60,000 &= 0.12 \times V \\ \text{Dividing both sides by } 0.12 \text{ yields:} \\ \$60,000/0.12 &= V = \$500,000 \end{aligned}$$

This equation is often called “IRV.”

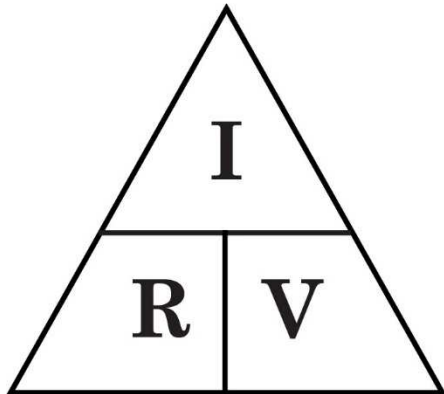

The IRV equation is visually represented by the triangle to the left. To determine the equation for any one of the three components, cover that element. For example, to determine value (V), cover the “ V ” in the diagram and the remaining items show I/R , so $V = I/R$, or value equals income divided by rate.

The traditional mathematical approach also works. For example, calculating value from the standard $I = R \times V$ equation, you can divide each side of the equation by R , resulting in $I/R = (R \times V)/R$. Reducing this equation results in $I/R = V$. Transposing the sides results in $V = I/R$, or value equals income divided by rate.

Depending on the variable in your equation, the solution for each item is:

Income	$I = R \times V$
Value	$V = I/R$
Rate	$R = I/V$

The income approach is primarily based on two principles of value, the principle of substitution and the principle of anticipation.

The principle of substitution says that property value tends to be set by the cost of acquiring an equally desirable substitute property provided such substitutes are available without costly delay.

The principle of anticipation says that market value is the present worth of all anticipated future benefits derived from the property. Those benefits must be either income or amenities. For most single-family, residential property, future benefits are measured in amenities (location, distance to work, quality of school system). For income-producing property, future benefits are measured by the estimated income the property will produce.

The Maine Supreme Court has ruled that assessors must at least consider all three approaches to value when assessing property. Usually one of the three methods is best suited for general assessment, but applying a second approach (and the third, if applicable) to validate values is a good practice. Different methods may be used for different property, as long as fair market value is achieved.

While there are many different types of income-producing property, this text will concentrate on residential rental property, or apartment buildings.

Definitions

Following are some of the terms associated with the income approach to value.

- Capitalization – The process of converting anticipated income from a property to a present value by dividing that income by an appropriate rate of return (capitalization rate). The two types of capitalization are direct capitalization and yield capitalization.
- Direct Capitalization – The direct capitalization method uses the estimated income for the first year following the date of valuation to calculate an estimated value of income-producing property.
- Certified Ratio – The ratio of assessed value for a municipality to the fair market value of that property. This ratio is “certified” by the municipality on its annual municipal valuation return.
- Discount Rate – The weighted average of mortgage interest rate and equity yield rate. In other words, the discount rate is the combination of the cost of borrowing

and the cost of investing. For purposes of this text, we will assume that funds used for purchase of property are borrowed, meaning the discount rate will be equal to the interest rate.

- **Effective Tax Rate** – municipal property tax (mill) rate multiplied by that municipality’s certified ratio. For example, if the mill rate is 20.00 (\$20.00/\$1,000 property value, or 2%) and property in the municipality is assessed at 90% of market value, the effective rate is 2% x 90%, or $0.02 \times 0.90 = 0.018$, 1.8%, or 18.00 mills. The effective tax rate multiplied by the market value of a property should equal the mill rate multiplied by the property’s assessed value.
- **Equity Yield Rate** – The required interest rate for investor funding.
- **Miscellaneous Income** – Income from sources incidental to the primary function of a property. For example, in rental property, miscellaneous income would be revenue generated from laundry facilities, garage, or storage space.
- **Mortgage Interest Rate** – The interest rate on borrowed money.
- **Net Operating Income** – Potential gross income, plus miscellaneous income, less vacancy and collection loss, less operating expenses.
- **Operating Expenses** – Generally, all recurring expenses that are subtracted from gross income to produce net operating income. Operating expenses fall into three categories:
 1. Fixed costs, such as real estate taxes and mortgage loan payments;
 2. Variable costs, such as administration, utilities, and supplies; and
 3. Replacement reserves – funds set aside for ongoing, periodic costs, such as roof repair or replacing appliances.
- **Potential Gross Income** – The maximum revenue expected to be generated in the future. For purposes of direct capitalization, estimated income for the first year following the valuation date is used for potential gross income.
- **Recapture Rate** – The annual rate at which an investment is returned over the economic life of property. The recapture rate applies only to buildings and other improvements. Land is not subject to a recapture rate because it generally does not have a finite economic life and does not lose value. The recapture rate is calculated by the equation: $1/(\text{economic life of asset})$. For example, if a building has an economic life of 25 years, the recapture rate is $1/25 = 0.04$ or 4%. The required annual return of investment for a 25-year asset is 4% each year.

- Vacancy and Collection Loss – Rent loss due to vacancy and loss from inability to collect all rent due.
- Yield Capitalization – The yield capitalization method uses income estimates from multiple years following the valuation date to calculate the estimated value of income-producing property.

Income

The income part of the $I = R \times V$ equation starts with an estimate of potential gross income (PGI). Using the direct capitalization method, PGI is an estimate of the maximum revenue expected to be generated in the year following the date of assessment. Estimating PGI for rental properties involves the consideration of the local rental market, including area rental prices, rental history, prospective tenant market, the ability for the average tenant to pay, and the demand for apartment space. You, as the assessor, must determine how the current market conditions will affect future rental income.

Income not directly related to the property as a whole is called miscellaneous income (MI). MI generated by residential rental property is income other than rent. Examples of miscellaneous income are income from laundry facilities or income from the rental of garage or storage space not included in rent.

In determining income, the assessor must also analyze market data to estimate vacancy and collection loss (VCL). VCL consists of rent lost while apartment units are vacant (usually in between tenants) and rent not paid by existing tenants. VCL estimates are based on market averages, rather than specific historical data from the subject property. Losses for any one building may be indicative of quality of management, rather than of the market forces. VCL is subtracted from potential gross income.

Operating expenses (OE), also subtracted from PGI, are expenses attributed to the production and maintenance of an income stream. There are typically three types of operating expenses: 1) fixed costs; 2) variable costs; and 3) replacement reserves. Fixed costs are expenses that do not fluctuate with occupancy rate or income. Fixed costs include property taxes, mortgage payments, and insurance. Variable costs are costs that fluctuate with occupancy rate or income. Variable costs include heat, electricity, and income taxes. Replacement reserves are amounts set aside for estimated annual expenses of short-lived items. Replacement reserves include funds for replacement of items such as refrigerators, dishwashers, and roofing. Sometimes these items are accounted for when purchased, under fixed or variable costs.

Chapter 6 – The Income Approach

Potential gross income, plus miscellaneous income, less vacancy and collection loss, less operating expenses equal the property's net operating income (NOI).

$$\begin{array}{r}
 \text{PGI} \\
 + \text{MI} \\
 - \text{VCL} \\
 - \text{OE} \\
 \hline
 = \text{NOI}
 \end{array}$$

Example. A property's estimated potential gross income (PGI) is \$100,000. Miscellaneous income (MI) is estimated to be \$10,000. A vacancy and collection loss (VCL) of 5% (0.05) of PGI is applied to the property and estimated operating expenses (OE) are \$75,000. If the direct capitalization rate (R) is 8% (0.08), calculate the estimated value of the property.

Determine NOI:

$$\begin{array}{r}
 \text{PGI} \quad \$100,000 \\
 + \text{MI} \quad \$10,000 \\
 - \text{VCL} \quad (\$5,000) \quad (\$100,000 \times 5\%) \\
 - \text{OE} \quad (\$75,000) \\
 \hline
 = \text{NOI} \quad \$30,000
 \end{array}$$

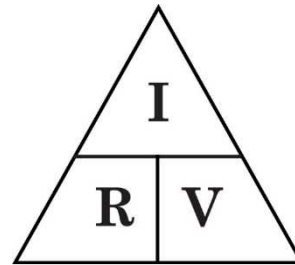

Calculate value using NOI and R. Using the IRV triangle, we see that $V = I/R$:

$$V = I/R = \$30,000/8\% = \underline{\underline{\$375,000}}$$

Class Problem

Answer on page 158

Problem 6.1. Tony is considering buying an apartment building and wants to know what it is worth. He estimates his potential gross income to be \$150,000, miscellaneous income to be \$12,000, vacancy and collection loss of 5% of PGI and operating expenses of \$80,000. What is the estimated NOI for this property? If Tony's estimated capitalization rate is 6.7%, what is the value of the property?

You may sometimes see the term *effective gross income*. This is a subtotal amount before the deduction of operating expenses.

$$\text{PGI} + \text{MI} - \text{VCL} = \text{effective gross income (EGI)}$$

$$\text{EGI} - \text{OE} = \text{NOI}$$

Capitalization

Capitalization is the process of converting anticipated income from a property to a present value by dividing that income by an appropriate rate of return, called the capitalization rate. The two types of capitalization are direct capitalization and yield capitalization. The direct capitalization method incorporates the estimated income for the first year following the date of valuation. The yield capitalization method uses income estimates from multiple years following the valuation date. This text follows the easier of the two methods, direct capitalization.

When analyzing an income stream, investors commonly are concerned with two things:

1. The return of investment, or recapture of the initial amount of money invested; and
2. The return on investment, the amount of profit generated by the investment.

Say, for example, you wanted to know how much you needed to invest today to have \$5 profit at the end of one year. The investment opportunity you are offered will pay 5% interest.

The basic formula for the income approach to value is $I = R \times V$, where V = value, I = income, and R = rate. In the above example, income is the return on investment (the amount of profit you want at the end of the year), rate is the interest rate, and value – the amount we are looking for – is the original investment. Using the IRV triangle, we see that $V = I/R$.

$$V = I/R = \$5/0.05 = \$100$$

You will need to invest \$100 today if you want to have \$5 profit in one year at a 5% interest rate. At the end of the year, the \$105 you have consists of \$100 return of investment and \$5 return on investment.

Applying this formula to the direct capitalization method, income (I) is the estimated income of a property over the following year, rate (R) is called the capitalization rate, and value (V) is the value estimate for the subject property.

Steps in the Direct Capitalization Process

1. Determine net operating income (I):

	Potential gross income (PGI)
Plus:	Miscellaneous income (MI)
Less:	Vacancy and collection losses (VCL)
Less:	<u>Operating expenses (OE)</u>
Equals:	Net Operating Income

2. Determine capitalization rate (R)

	Recapture rate
Plus:	Effective tax rate
Plus:	<u>Interest rate</u>
Equals:	Capitalization Rate

3. Compute value (V)

$$V = \text{Net operating income/capitalization rate} = I/R$$

If the valuation includes both land and buildings, you will need to follow these three steps for each, separating the land from the buildings and other improvements.

Determining the Capitalization Rate

There are three components in a capitalization rate for developed property. They are:

- discount rate
 1. mortgage interest rate = return on borrowed funds
 2. equity yield rate = return on investor's equityFor purposes of this text, we will assume that funds used for purchase of property are borrowed, meaning the discount rate will be equal to the mortgage interest rate.
- recapture rate
- effective tax rate

The *discount rate* is made up of two separate rates, the return on borrowed money, the interest rate, and the return on investor's equity, a yield rate. The yield rate is the rate of return that is high enough to convince a person with cash to invest in income-producing property. The calculations in this text will assume that property is purchased entirely with borrowed money and, therefore, the discount rate is equal to the interest rate (or mortgage interest rate) charged for borrowed money.

The *recapture rate* is the annual rate at which an investment is returned over the economic life of property. The recapture rate applies only to buildings and other improvements which lose value throughout their useful life due to depreciation over time, known as a wasting or depreciable asset. Land is not subject to a recapture rate because it generally does not have a finite economic life and does not lose value. The recapture rate is the inverse of the economic life of the building. For example, if a building has an economic life of 25 years, the recapture rate is $1/25 = 0.04$ or 4%.

The *effective tax rate* is calculated by multiplying the municipal property tax (mill) rate by that municipality's certified ratio. For example, if the mill rate is 20.00 (\$20.00/\$1,000 property value, or 2%) and property in the municipality is assessed at 90% of market value, the effective rate is $2\% \times 90\%$, or $0.02 \times 0.90 = 0.018$, or 1.8%.

All three components are applicable to buildings and improvements, reflecting the need to recapture the value of the depreciating improvements over time. Recapturing the value of land, except in rare circumstances, is given and therefore not a factor. A capitalization rate for land will be therefore be lower than the corresponding rate for buildings and improvements.

Example. Christina, an investor, is considering purchasing an apartment building. The estimated remaining economic life of the building is 25 years, the current mortgage interest rate is 3.5%, the local mill rate is 11.0 and the municipality reports a 90% certified ratio. What are the capitalization rates for the land and for the building?

$R_{\text{land}} = \text{interest rate} + \text{effective tax rate}$

Interest rate = 3.5% = 0.035

Effective tax rate = local property tax rate x certified ratio = 11 mills x 90%
= 11 x 0.90 = 9.9 mills = 0.0099

$R_{\text{land}} = 0.035 + 0.0099 = \underline{0.0449 \text{ or } 4.49\%}$

$R_{\text{bldg}} = \text{interest rate} + \text{effective tax rate} + \text{recapture rate} = R_{\text{land}} + \text{recapture rate}$

Recapture rate = 1/economic life = 1/25 = 0.040

$R_{\text{bldg}} = 0.0449 + 0.040 = \underline{0.0849 \text{ or } 8.49\%}$

Class Problem

Answer on page 158

Problem 6.2. Tony, from Problem 6.1, realizes that the capitalization rate he used to determine the apartment building value only included the interest rate of 4% and the building recapture rate of 2.7%. If the local property tax rate is 20 mills and the municipality declares a 100% certified ratio, what are the capitalization rates for land and for the improvements?

Calculating Value

Sometimes, you can combine the capitalization rate for land and the capitalization rate for improvements into a blended rate that applies for the entire property. Alternately, an assessor will calculate the value of land and improvements separately. To create these separate values, the assessor must apportion income between the land and the buildings.

When applying different capitalization rates to land and buildings, the value of the total property becomes: $V = V_{\text{land}} + V_{\text{bldg}}$. Calculating value for each component, the basic equation breaks down as follows:

$$V = V_{\text{land}} + V_{\text{bldg}}$$

$$V_{\text{land}} = I_{\text{land}}/R_{\text{land}}$$

$$V_{\text{bldg}} = I_{\text{bldg}}/R_{\text{bldg}}$$

Therefore, $V = (I_{\text{land}}/R_{\text{land}}) + (I_{\text{bldg}}/R_{\text{bldg}})$

This method of determining value is called the Land/Building Residual technique and is best illustrated by a grid:

	Income	Rate	Value
Land			
Building			
Total			

Filling in the grid with available information allows calculation of any missing information, since, if we have 2 items in either a row or column we can calculate the third item using the IRV formula or addition/subtraction.

After calculating each component of value, enter the result in this grid to calculate the total value of the property.

Example. Errol owns an apartment building that he would like to sell. Before selling, he would like to find out how much he can get for the property. He estimates that his net operating income for the next year will be \$50,000. Of that total, he estimates that 20% of his income is due to the land, since he has off-street parking for all tenants and can charge higher than average rent for the apartments. The

Chapter 6 – The Income Approach

municipal tax rate is 15 mills and the municipal certified ratio is 100%. The area mortgage interest rate is 3.75% and the remaining economic life of the building is 16 years.

Our first step would be to fill the grid in with any available information from the information we are given.

1) What is the income attributable to the land?

$$I_L = \text{NOI} \times 20\% = \$50,000 \times 0.20 = \$10,000$$

2) What is the effective tax rate?

$$\text{ETR} = \text{mill rate} \times \text{certified ratio} = 15 \text{ mills} \times 100\% = 15 \text{ mills or } 0.015$$

3) What is the recapture rate?

$$\text{Recapture rate} = 1/\text{economic life} = 1/16 = 0.0625$$

4) What is the capitalization rate for the land?

$$R_L = \text{interest} + \text{ETR} = 0.0375 + 0.015 = 0.0525$$

5) What is the capitalization rate for the building?

$$R_B = \text{interest} + \text{ETR} + \text{recapture rate} = 0.0375 + 0.015 + 0.0625 = 0.115$$

	Income	Rate	Value
Land	10,000	0.0525	
Building		0.115	
Total	50,000		

The blanks in the grid can now be filled in.

6) What is the income attributable to the building?

Chapter 6 – The Income Approach

$$I_B = \text{NOI} - I_L = \$50,000 - \$10,000 = \$40,000$$

7) What is the value of the land?

$$V_L = I_L/R_L = \$10,000/0.0525 = \$190,476$$

8) What is the value of the building?

$$V_B = I_B/R_B = \$40,000/0.115 = \$347,826$$

9) What is the total value of the property?

$$V = V_L + V_B = \$190,476 + \$347,826 = \$538,302 \text{ or } \$538,000 \text{ rounded to the nearest } \$1,000$$

Errol would like to get at least \$538,000 for his property.

Using the grid for this problem shows the results more visually.

	Income	Rate	Value
Land	\$10,000	0.0525	\$190,476
Building	\$40,000	0.115	\$347,826
Total	\$50,000		\$538,302

Class Problems

Answers on page 158

Problem 6.3. Bob, a developer, is planning to build an apartment building on a vacant parcel of land for sale. He wants to know if the project is a good investment. To determine this, he needs an estimate of the property value including the land and building. Bob has put together the following estimates:

PGI = \$35,000

MI = \$1,500

VCL = 3.5% of PGI

OE = \$8,750

Sale price of land = \$50,000

Economic life of proposed building = 40 years

Current mortgage interest rate = 4.0%

Local tax rate = 20 mills

Municipal certified ratio = 90%

- 1) What is the net operating income?

- 2) What is the effective tax rate?

- 3) What is the recapture rate?

- 4) What is the capitalization rate for the land?

- 5) What is the capitalization rate for the building?

- 6) What is the income attributable to the land?

- 7) What is the income attributable to the building?

- 8) What is the total value of the property?

	Income	Rate	Value
Land			
Building			
Total			

Chapter 6 – The Income Approach

Problem 6.4. Bob now wants to purchase an existing apartment building that is on the market for \$200,000. He wants to know if the property is a good investment. To determine this, he needs an estimate of the property value including the land and building. Bob has put together the following estimates:

PGI = \$25,000

MI = \$1,000

VCL = 3.5% of PGI

OE = \$5,000

Estimated land value = \$60,000

Remaining economic life of building = 20 years

Current mortgage interest rate = 3.5%

Local tax rate = 20 mills

Municipal certified ratio = 90%

Should Bob purchase this building? Hint: Follow the same series of questions from Problem 6.3.

	Income	Rate	Value
Land			
Building			
Total			

Chapter 6 – The Income Approach

Problem 6.5. Bob, looking to expand his property holdings, wants to buy the 8-unit apartment building next door. The owner of the building is asking \$700,000 for it. Bob has put together the following estimates:

PGI = \$80,000

MI = \$6,000

VCL = 5% of PGI

OE = \$10,000

Estimated land value = \$50,000

Remaining economic life of building = 23 years

Current mortgage interest rate = 4.2%

Local tax rate = 20 mills

Municipal certified ratio = 85%

Should Bob make this investment?

	Income	Rate	Value
Land			
Building			
Total			

Chapter 6 – The Income Approach

Problem 6.6. Bob, still not satisfied, wants to build an even bigger apartment building on a vacant parcel of land for sale. He wants to know if the project is a good investment. To determine this, he needs an estimate of the property value including the land and building. Bob has put together the following estimates:

- PGI = \$100,000
- MI = \$6,000
- VCL = 5% of PGI
- OE = \$25,000
- Sale price of land = \$55,000
- Economic life of proposed building = 40 years
- Current mortgage interest rate = 4.5%
- Local tax rate = 18 mills
- Municipal certified ratio = 85%

What is the property value estimate, to the nearest \$1,000?

	Income	Rate	Value
Land			
Building			
Total			

CHAPTER 7

SALES RATIO STUDIES

Introduction

The Maine Constitution requires, “all taxes upon real and personal estate, assessed by authority of this state, shall be apportioned and assessed equally according to the just value thereof.” In keeping with this constitutional provision, state of Maine law requires assessors to perform annual sales ratio studies (36 M.R.S. § 328(8)).

Beyond the legal requirement, sales ratio studies are the foundation of maintaining an equitable assessment base. Sales ratio studies are the primary administrative tool for establishing or reviewing municipal assessments. Regular studies comparing assessed values to sales, when done correctly, provide the assessor with information necessary for equalization programs, keeping assessments current and allowing an adequate defense of assessments coming under appeal.

Verification of Data

When undertaking a sales ratio study, it is important to use data representative of the market. All sales used in a sales ratio study must be unbiased sales, referred to as arm’s-length transactions.

An arm’s-length transaction is a sale between a willing and informed buyer and a willing and informed seller, neither under any undue pressure to buy or sell, with a price expressed in dollars. The property sold must have spent a reasonable amount of time available for sale and normal market conditions must exist. The buyer and seller must be unrelated. Foreclosure sales and sales between family members are typical examples of sales that are not arm’s-length transactions.

While there are many ways to collect information concerning the sale prices of property, the Real Estate Transfer Tax Declaration (RETTD), completed at the time of sale, is a frequently used source. If an assessor uses an RETTD in a sales ratio study, the assessor should verify the data is correct. One common verification tool is a sales qualification form completed by the buyer. Such a form, when completed, both documents and validates the data.

Once sales are verified, the assessor’s next step is to ensure the sales represent the property assessed. For example, a property may have been improved since the last assessment, but prior to the sale. This sale does not reflect the property as it existed

at the time of assessment, and should be excluded from the sales ratio study. Other discrepancies may be:

- Change in use, such as residential to commercial;
- Personal property may be included in the selling price (a camp may include furnishings or a boat, etc.);
- Rezoning;
- Neighborhood changes;
- Sale of a portion of the land – a real estate split;
- Land is subject to encumbrances; or
- Land is classified as tree growth, farmland, or other current use.

Time Period for Sales

Sales in a sales ratio study should have occurred within a set of dates called the base period. The base period is the 12-month period from July 1 through June 30 that includes the April 1 assessment date for the year under review. For example, if an assessor is doing a sales ratio study for 2017, sales from July 1, 2016 through June 30, 2017 will be included.

A minimum of 12 sales are required for an adequate sales ratio study. If there aren't enough sales during the base period, an assessor may expand the sampling period to include sales during an 18-month period, by expanding the base period by three months on each end. In the above example, the expanded sales period would be April 1, 2016 through September 30, 2017.

If the 18-month expanded sales period still does not provide 12 usable sales, the assessor can then include the sales during a two-year period by expanding the 18-month period by another three months on each end. In the above example, the additionally expanded sales period would be January 1, 2016 through December 31, 2017.

If the market has changed during the period from which sales are collected, some sales may need to be adjusted to account for the change. If the market was static, then no adjustment will be needed.

If enough sales exist in the base period or expanded periods, an assessor may conduct segregated ratio studies. A segregated ratio study analyzes a certain type of property, such as waterfront or condominium. In certain circumstances, segregated ratio studies may be required.

Definitions

The following definitions refer to this set of numbers.

	Sales	Assessed Values	Sales Ratio	Deviation
#1	\$ 6,000	\$ 3,600	60%	12
#2	\$ 7,000	\$ 4,500	64%	8
#3	\$ 8,000	\$ 5,600	70%	2
#4	\$ 9,500	\$ 6,700	71%	1
#5	\$ 9,500	\$ 6,700	71%	1
#6	\$ 9,500	\$ 6,700	71%	1
#7	\$ 9,500	\$ 6,700	71%	1
#8	\$ 10,750	\$ 7,700	72%	0
#9	\$ 12,250	\$ 9,000	73%	1
#10	\$ 12,500	\$ 9,400	75%	3
#11	\$ 20,000	\$ 17,000	85%	13
#12	\$ 26,000	\$ 25,000	96%	24
Σ	\$140,500	\$108,600	72%	67

Assessed value. A property’s assessed value is the value assigned to that property by the municipality, for purposes of calculating property tax.

Average deviation. Average deviation is calculated by summing the deviations of all the sales ratios in a ratio study and dividing that sum by the total number of sales ratios in that study. In the above example, the average deviation is calculated as:

$$(12+8+2+1+1+1+0+1+3+13+24)/12 = 67/12 = 5.6$$

Average ratio. The average ratio is calculated by summing the sales ratios in the central range of a ratio study (the central 70%, excluding the top 15% and the bottom

15%) and dividing that sum by the total number of sales ratios in the central range of that study. In the above example, the average ratio is calculated as:

$$(70 + 71 + 71 + 71 + 71 + 72 + 73 + 75)/8 = 574/8 = 71.75, \text{ rounded to } 72$$

Classification. Classification, abbreviated “class,” is a specific type of property. For purposes of this text, we will use the classifications residential, land, condominium, or waterfront.

Central range. Most of the calculations in a sales ratio study involve only a portion of the sales included in the study. The sales used for these calculations are called the central range and the sales excluded are called the outliers. To determine the central range, you must arrange sales with the sales ratios from lowest to highest. The sales ratio is the assessed value divided by the sale price for each sale. The central range is the 70% of the sales in the middle of the sales ratio list ordered by ratio. The outliers are the sales not included in the central range. For the above example, the central range is calculated as:

$$12 \times 70\% = 8.4, \text{ rounded to } 8$$

The central 8 sales exclude the 2 highest sales ratio sales and the 2 lowest sales ratio sales, leaving sale #s 3 – 10

The number of outliers must be even, so it may be easier to calculate the number of outliers first, then determine the remaining central range.

Certified ratio. A municipality’s certified ratio is the overall ratio of assessed value to market value for the entire municipality, as determined by the municipality and reported on the annual municipal valuation return. The primary goal of a sales ratio study is to determine a municipality’s certified ratio, which is used for prorating benefits such as the homestead exemption and payments to the municipality such as reimbursements for the Business Equipment Tax Exemption program. Maine law requires that each municipality maintain a certified ratio between 70% and 110% (36 M.R.S. § 327).

Deviation. The deviation for a single sale is equal to the absolute value of the difference between that property’s sales ratio and the average ratio.

Mean. The mean, or arithmetic mean, is most commonly called the average. It is calculated by adding all of the values in a series and dividing the total by the number of items in that series. For the above set of sales, the mean is:

$$(\$6,000+\$7,000+\$8,000+\$9,500+\$9,500+\$9,500+\$9,500+\$10,750+\$12,250+\$12,250+\$20,000+\$26,000)/12 = \$140,500/12 = \underline{\underline{\$11,708}}$$

Median. The median value is the value at the midpoint of the range. The median is the value at which half of the samples are higher and half are lower. In the above set, the median is between #6 and #7. When an even number of items are under study, the median is determined by averaging the two middle values. The two middle values in this example are #6 \$9,500 and #7 \$9,500. The median is calculated as:

$$(\$9,500 + \$9,500) / 2 = \$9,500$$

Mode. The mode is the value occurring most frequently. In the above number set, the mode is \$9,500, since that value occurs four times, which is more often than any other number is repeated.

Outlier. Most of the calculations in a sales ratio study involve only a portion of the sales included in the study. The sales used for these calculations are called the central range and the sales excluded are called the outliers. Outliers are not the same as sales that are not arm's-length transactions. Outliers are arm's-length transactions that are included in the sales ratio study, but excluded for some of the calculations for the study. Some calculations, such as the weighted average, include the outliers.

To calculate the outliers, you must first arrange sales according to the sales ratios from lowest to highest. Next, multiply the number of sales in the study by 30% (15% of the lowest ratios and 15% of the highest ratios will be removed) and round the result up to the next even number. This is necessary to get an equal number of outliers on both ends of the study. For example, if you have a study containing 28 sales, 30% of that total equals 8.4. This must be rounded up to 10 to exclude 5 sales at the top and 5 sales at the bottom of the study.

Quality rating. The quality rating, or coefficient of dispersion, for a municipality is calculated by dividing the average deviation by the average ratio and multiplying the result by 100. Quality rating is a measure of how accurate a municipality's assessments are. Maine law requires each municipality to maintain a quality rating of no higher than 20 (36 M.R.S. § 327). For the above example, the quality rating is calculated as:

$$(5.6 / 72) \times 100 = 7.8$$

Sales Ratio. The sales ratio is calculated by dividing a property's assessed value by its selling price. For example, in the above set, the sales ratio for the first sale listed is $\$3,600 / \$6,000 = 0.60$. This means that the assessed value is 60% of market value.

Weighted average. The weighted average is calculated by dividing the total assessed values by the total sales prices for all sales in a sales ratio. For the numbers above, the weighted average is calculated:

$$\text{Assessed Values/Sales} = \$108,600/\$140,500 = 0.7730 \text{ or } 77.3\%$$

The following pages include a ratio study example followed by ratio study problems. Each problem ratio study contains two or more classes of properties, which are further divided into separate “segregated” studies.

Chapter 7 – Sales Ratio Studies

Example.

Item No.	Class	Mo/Yr	Sales Price	Local Assessment	Ratio	Whole Number	Deviation
1	R	5/1	425,000	255,000	0.60	60	17
2	R	4/1	435,000	269,700	0.62	62	15
3	R	9/1	350,000	220,500	0.63	63	14
4	R	2/1	219,000	142,500	0.65	65	12
5	1 R	3/1	335,000	224,500	0.67	67	10
6	2 R	7/1	394,900	268,700	0.68	68	9
7	3 R	7/1	287,000	201,000	0.70	70	7
8	4 R	11/1	225,000	160,000	0.71	71	6
9	5 R	6/1	195,000	138,500	0.71	71	6
10	6 R	4/1	315,000	226,800	0.72	72	5
11	7 R	10/1	272,000	201,200	0.74	74	3
12	8 R	3/1	255,500	189,000	0.74	74	3
13	9 R	5/1	322,000	241,500	0.75	75	2
14	10 R	1/1	345,000	258,700	0.75	75	2
15	11 R	4/1	415,000	311,200	0.75	75	2
16	12 R	5/1	235,000	181,000	0.77	77	0
17	13 R	12/1	279,000	217,600	0.78	78	1
18	14 R	11/1	328,500	262,400	0.80	80	3
19	15 R	9/1	244,000	197,500	0.81	81	4
20	16 R	7/1	259,000	215,000	0.83	83	6
21	17 R	10/1	265,000	225,000	0.85	85	8
22	18 R	3/1	295,000	250,800	0.85	85	8
23	19 R	4/1	316,000	274,900	0.87	87	10
24	20 R	9/1	339,000	295,000	0.87	87	10
25	R	2/1	288,500	259,600	0.90	90	13
26	R	11/1	254,500	229,000	0.90	90	13
27	R	8/1	325,000	298,500	0.92	92	15
28	R	7/1	262,000	246,200	0.94	94	17
TOTALS			8,480,900	6,461,300		1535	221

Outliers	=	Total Sales x .15			
Weighted Average Ratio	=	Assessment ÷ Sale Price			
Average Ratio	=	Central Section Total ÷ Number of Items in Cental Section			
Average Deviation	=	Total of ALL Deviations ÷ Total of COUNT of SALES			
Quality Rating	=	Average Deviation ÷ Average Ratio			
Outliers	=	28	x	0.15	4.2
Weighted Average Ratio	=	6,461,300	÷	8,480,900	0.76
Average Ratio	=	1535	÷	20	77
Average Deviation	=	221	÷	28	7.9
Quality Rating	=	7.9	÷	77	0.10

Class Problems

Answers on page 166

Problem 7.1 – sales ratio study. Determine the weighted average ratio, the average ratio, the average deviation, and the quality rating for the sales data below.

ITEM NO.		CLASS	MO/YR		SALE PRICE	ASSESSMENT	RATIO	DEV.	
1		R	04/09		\$269,000	\$161,400	60%		
2		M	06/09		\$172,000	\$106,600	62%		
3		M	12/09		\$165,000	\$102,300	62%		
4		R	02/09		\$174,500	\$118,700	68%		
5		R	03/09		\$232,500	\$165,100	71%		
6		R	02/09		\$199,000	\$143,300	72%		
7	1	M	10/09		\$162,000	\$119,900	74%		
8	2	R	09/09		\$145,000	\$107,300	74%		
9	3	M	06/09		\$159,000	\$119,200	75%		
10	4	R	08/09		\$205,000	\$157,800	77%		
11	5	R	01/09		\$158,900	\$122,400	77%		
12	6	M	02/09		\$150,000	\$115,500	77%		
13	7	M	05/09		\$148,000	\$117,700	80%		
14	8	R	05/09		\$215,000	\$174,200	81%		
15	9	R	09/09		\$178,000	\$146,000	82%		
16	10	R	11/09		\$209,900	\$176,300	84%		
17	11	R	03/09		\$150,000	\$126,000	84%		
18	12	R	04/09		\$167,500	\$142,400	85%		
19	13	M	07/09		\$138,500	\$120,500	87%		
20	14	R	04/09		\$239,000	\$207,900	87%		
21	15	M	11/09		\$145,000	\$127,600	88%		
22	16	R	10/09		\$244,000	\$219,600	90%		
23	17	R	03/09		\$177,700	\$159,900	90%		
24	18	M	08/09		\$142,000	\$129,200	91%		
25	19	R	02/09		\$180,000	\$163,800	91%		
26	20	R	07/09		\$224,500	\$206,500	92%		
27	21	M	05/09		\$135,000	\$126,900	94%		
28	22	R	10/09		\$149,000	\$140,000	94%		
29	23	R	01/09		\$192,500	\$182,900	95%		
30	24	M	11/09		\$139,900	\$132,900	95%		
31	25	R	05/09		\$136,500	\$129,700	95%		
32	26	R	08/09		\$188,000	\$184,200	98%		
33	27	M	04/09		\$147,000	\$145,500	99%		
34	28	M	04/09		\$132,600	\$132,700	100%		
35		R	07/09		\$184,500	\$188,200	102%		
36		R	12/09		\$156,600	\$164,400	105%		
37		M	10/09		\$139,000	\$150,100	108%		
38		R	08/09		\$125,000	\$137,500	110%		
39		M	09/09		\$125,000	\$140,100	112%		
40		R	12/09		\$149,000	\$177,300	119%		

Weighted Average Ratio:									
Average Ratio:									
Average Deviation:									
Quality Rating:									
							CLASSIFICATIONS		
							L=LAND		
							M=CONDOS		
							R=RESIDENTIAL		
							W=WATERFRONT		

Chapter 7 – Sales Ratio Studies

7.3 – segregated ratio study for residential property sales from Problem

7.1. Determine the weighted average ratio, the average ratio, the average deviation, and the quality rating for the sales data below.

ITEM NO.	CLASS	MO/YR	SALE PRICE	ASSESSMENT	RATIO	DEV.
1	R	04/09	\$269,000	\$161,400	60%	
2	R	02/09	\$174,500	\$118,700	68%	
3	R	03/09	\$232,500	\$165,100	71%	
4	R	02/09	\$199,000	\$143,300	72%	
5	R	09/09	\$145,000	\$107,300	74%	
6	R	08/09	\$205,000	\$157,800	77%	
7	R	01/09	\$158,900	\$122,400	77%	
8	R	05/09	\$215,000	\$174,200	81%	
9	R	09/09	\$178,000	\$146,000	82%	
10	R	11/09	\$209,900	\$176,300	84%	
11	R	03/09	\$150,000	\$126,000	84%	
12	R	04/09	\$167,500	\$142,400	85%	
13	R	04/09	\$239,000	\$207,900	87%	
14	R	10/09	\$244,000	\$219,600	90%	
15	R	03/09	\$177,700	\$159,900	90%	
16	R	02/09	\$180,000	\$163,800	91%	
17	R	07/09	\$224,500	\$206,500	92%	
18	R	10/09	\$149,000	\$140,000	94%	
19	R	01/09	\$192,500	\$182,900	95%	
20	R	05/09	\$136,500	\$129,700	95%	
21	R	08/09	\$188,000	\$184,200	98%	
22	R	07/09	\$184,500	\$188,200	102%	
23	R	12/09	\$156,600	\$164,400	105%	
24	R	08/09	\$125,000	\$137,500	110%	
25	R	12/09	\$149,000	\$177,300	119%	
			Totals:			
Weighted Average Ratio:						
Average Ratio:						
Average Deviation:						
Quality Rating:						

Chapter 7 – Sales Ratio Studies

Problem 7.6 – segregated ratio study for residential property sales from Problem 7.4. Determine the weighted average ratio, the average ratio, the average deviation, and the quality rating for the sales data below.

ITEM NO.	CLASS	MO/YR	SALE PRICE	ASSESSMENT	RATIO	DEV.
1	R	09/09	\$315,500	\$167,200	53%	
2	R	11/09	\$258,000	\$149,600	58%	
3	R	02/09	\$226,500	\$140,400	62%	
4	R	05/09	\$278,900	\$175,700	63%	
5	R	12/09	\$198,000	\$126,700	64%	
6	R	08/09	\$269,000	\$172,200	64%	
7	R	02/09	\$205,000	\$133,000	65%	
8	R	05/09	\$188,000	\$124,000	66%	
9	R	04/09	\$322,000	\$212,500	66%	
10	R	06/09	\$164,500	\$111,900	68%	
11	R	11/09	\$305,000	\$210,500	69%	
12	R	02/09	\$139,000	\$97,000	70%	
13	R	01/09	\$297,500	\$208,200	70%	
14	R	10/09	\$162,500	\$115,400	71%	
15	R	03/09	\$292,000	\$210,200	72%	
16	R	08/09	\$178,000	\$131,700	74%	
17	R	01/09	\$195,000	\$150,000	77%	
18	R	05/09	\$270,000	\$207,900	77%	
19	R	12/09	\$284,900	\$222,200	78%	
20	R	08/09	\$136,000	\$108,800	80%	
21	R	11/09	\$265,000	\$225,200	85%	
22	R	03/09	\$142,500	\$128,300	90%	
23	R	09/09	\$162,000	\$153,900	95%	
Totals						
Weighted Average Ratio:						
Average Ratio:						
Average Deviation:						
Quality Rating:						

Chapter 7 – Sales Ratio Studies

Problem 7.7 – sales ratio study. Determine the weighted average ratio, the average ratio, the average deviation, and the quality rating for the sales data below.

ITEM NO.		CLASS	MO/YR		SALE PRICE	ASSESSMENT	RATIO	DEV.	
1		W	06/09		\$427,500	\$171,000	40%		
2		W	07/09		\$376,000	\$150,400	40%		
3		R	03/09		\$259,000	\$106,200	41%		
4		W	11/09		\$419,000	\$175,900	42%		
5		R	10/09		\$249,000	\$109,600	44%		
6	1	W	02/09		\$400,000	\$180,100	45%		
7	2	W	05/09		\$365,000	\$171,500	47%		
8	3	R	05/09		\$245,000	\$117,600	48%		
9	4	W	04/09		\$395,000	\$189,600	48%		
10	5	R	10/09		\$222,500	\$111,300	50%		
11	6	W	09/09		\$399,000	\$203,500	51%		
12	7	W	02/09		\$445,000	\$235,800	53%		
13	8	W	12/09		\$386,900	\$212,800	55%		
14	9	W	04/09		\$355,000	\$195,200	55%		
15	10	W	07/09		\$349,000	\$198,900	57%		
16	11	R	06/09		\$214,500	\$128,700	60%		
17	12	W	11/09		\$389,000	\$241,200	62%		
18	13	W	12/09		\$345,500	\$214,200	62%		
19	14	R	03/09		\$188,000	\$122,200	65%		
20	15	W	02/09		\$375,000	\$243,700	65%		
21	16	R	06/09		\$139,000	\$94,500	68%		
22	17	W	06/09		\$333,000	\$229,800	69%		
23	18	R	04/09		\$177,900	\$124,500	70%		
24	19	R	08/09		\$227,000	\$163,400	72%		
25	20	R	10/09		\$199,000	\$149,200	75%		
26	21	R	07/09		\$195,000	\$154,000	79%		
27	22	R	05/09		\$134,500	\$110,300	82%		
28	23	R	04/09		\$250,000	\$210,000	84%		
29	24	R	06/09		\$148,000	\$125,800	85%		
30		R	12/09		\$164,500	\$141,500	86%		
31		R	09/09		\$132,000	\$116,200	88%		
32		R	11/09		\$129,000	\$117,400	91%		
33		R	07/09		\$142,500	\$131,100	92%		
34		R	04/09		\$130,000	\$123,500	95%		

Totals

Weighted Average Ratio:

Average Ratio:

Average Deviation:

Quality Rating:

Chapter 7 – Sales Ratio Studies

Problem 7.9 – segregated ratio study for waterfront property sales from Problem 7.7. Determine the weighted average ratio, the average ratio, the average deviation, and the quality rating for the sales data below.

ITEM NO.	CLASS	MO/YR	SALE PRICE	ASSESSMENT	RATIO	DEV.
1	W	06/09	\$427,500	\$171,000	40%	
2	W	07/09	\$376,000	\$150,400	40%	
3	W	11/09	\$419,000	\$175,900	42%	
4	W	02/09	\$400,000	\$180,100	45%	
5	W	05/09	\$365,000	\$171,500	47%	
6	W	04/09	\$395,000	\$189,600	48%	
7	W	09/09	\$399,000	\$203,500	51%	
8	W	02/09	\$445,000	\$235,800	53%	
9	W	04/09	\$355,000	\$195,200	55%	
10	W	12/09	\$386,900	\$212,800	55%	
11	W	07/09	\$349,000	\$198,900	57%	
12	W	12/09	\$345,500	\$214,200	62%	
13	W	11/09	\$389,000	\$241,200	62%	
14	W	02/09	\$375,000	\$243,700	65%	
15	W	06/09	\$333,000	\$229,800	69%	
			Total			
Weighted Average Ratio:						
Average Ratio:						
Average Deviation:						
Quality Rating:						

ANSWERS TO CLASS PROBLEMS

Chapter 2 - Answers

Problem 2.1. Standard depth = 220ft; FFV = \$350/ft

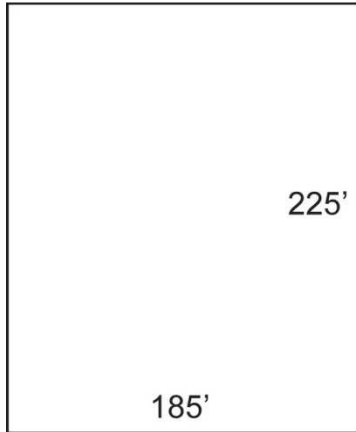

$$1) DF = \sqrt{(\text{parcel depth}/\text{standard depth})} \\ = \sqrt{(225\text{ft}/220\text{ft})} = \sqrt{1.02} = 1.01$$

$$2) \text{Value} = \text{FFV} \times \text{DF} \times \text{FF} = \$350/\text{ft} \times 1.01 \times 185\text{ft} = \\ \$65,397.50 \text{ rounded to } \underline{\$65,400}$$

Problem 2.2. Standard depth = 220ft; FFV = \$175/ft

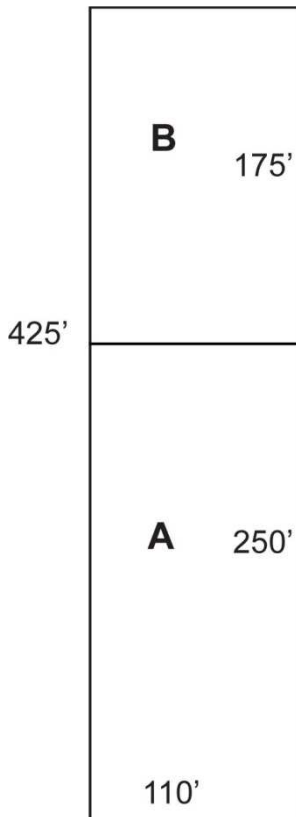

$$1) DF_{A+B} = \sqrt{(\text{parcel depth}/\text{standard depth})} \\ = \sqrt{(425\text{ft}/220\text{ft})} = \sqrt{1.93} = 1.39$$

$$DF_A = \sqrt{(\text{parcel depth}/\text{standard depth})} \\ = \sqrt{(250\text{ft}/220\text{ft})} = \sqrt{1.14} = 1.07$$

$$DF_B = 1.39 - 1.07 = 0.32$$

$$2) \text{Value}_B = \text{FFV} \times \text{DF}_B \times \text{FF} = \$175/\text{ft} \times 0.32 \times 110\text{ft} = \$6,160 \\ \text{rounded to } \underline{\$6,200}$$

Problem 2.13. Standard depth = 125ft; FFV = \$350/ft

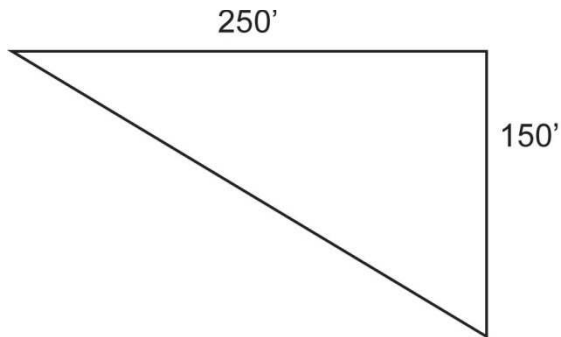

$$1) DF = \sqrt{(\text{parcel depth}/\text{standard depth})} \\ = \sqrt{(150\text{ft}/125\text{ft})} = \sqrt{1.20} = 1.10$$

$$2) \text{Value} = \text{FFV} \times \text{DF} \times \text{FF} \times \text{TF}_N = \$350/\text{ft} \times 1.10 \times 250\text{ft} \times 0.30 = \$28,875 \text{ rounded to } \underline{\$28,900}$$

Problem 2.14. Standard depth = 125ft; FFV = \$325/ft

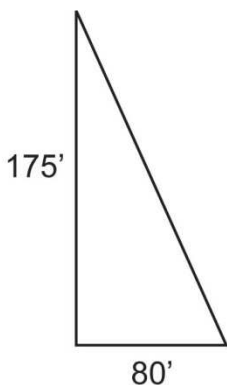

$$1) DF = \sqrt{(\text{parcel depth}/\text{standard depth})} \\ = \sqrt{(175\text{ft}/125\text{ft})} = \sqrt{1.40} = 1.18$$

$$2) \text{Value} = \text{FFV} \times \text{DF} \times \text{FF} \times \text{TF}_D = \$325/\text{ft} \times 1.18 \times 80\text{ft} \times 0.60 = \$18,408 \text{ rounded to } \underline{\$18,400}$$

Problem 2.20. Standard depth = 125ft; FFV = \$200/ft

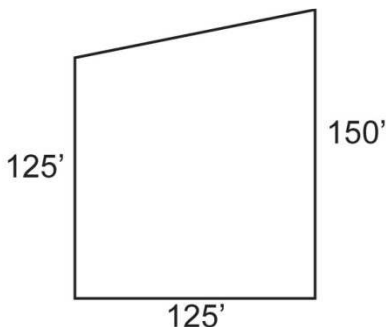

$$\text{Average depth} = (150\text{ft} + 125\text{ft})/2 = 275\text{ft}/2 = 137.5\text{ft}$$

$$1) DF = \sqrt{(\text{parcel depth}/\text{standard depth})} \\ = \sqrt{(137.5\text{ft}/125\text{ft})} = \sqrt{1.10} = 1.05$$

$$2) \text{Value} = \text{FFV} \times \text{DF} \times \text{FF} = \$200/\text{ft} \times 1.05 \times 125\text{ft} = \$26,250 \text{ rounded to } \underline{\$26,200}$$

Problem 2.24. Standard depth = 125ft; FFV = \$240/ft

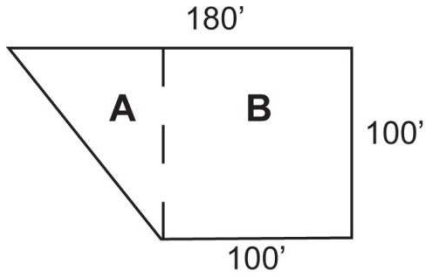

$$1) DF_A = \sqrt{(\text{parcel depth}/\text{standard depth})}$$

$$= \sqrt{(100\text{ft}/125\text{ft})} = \sqrt{0.80} = 0.89$$

$$2) \text{Value}_A = \text{FFV} \times DF_A \times \text{FF}_A \times \text{TF}_N = \$240/\text{ft} \times 0.89 \times (180\text{ft} - 100\text{ft}) \times 0.30 = \$213.60/\text{ft} \times 80\text{ft} \times 0.30 = \underline{\$5,126.40}$$

$$1) DF_B = \sqrt{(\text{parcel depth}/\text{standard depth})}$$

$$= \sqrt{(100\text{ft}/125\text{ft})} = \sqrt{0.80} = 0.89$$

$$2) \text{Value}_B = \text{FFV} \times DF_B \times \text{FF}_B = \$240/\text{ft} \times 0.89 \times 100\text{ft} = \underline{\$21,360}$$

Parcel Value = Value_A + Value_B = \$5,126.40 + \$21,360 = \$26,486.40 rounded to \$26,500

Problem 2.28. Standard depth = 125ft; FFV = \$330/ft

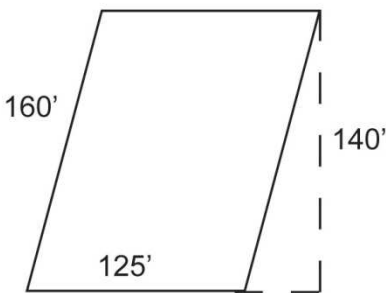

$$1) DF = \sqrt{(\text{parcel depth}/\text{standard depth})}$$

$$= \sqrt{(140\text{ft}/125\text{ft})} = \sqrt{1.12} = 1.06$$

$$2) \text{Value} = \text{FFV} \times DF \times \text{FF} = \$330/\text{ft} \times 1.06 \times 125\text{ft} = \$43,725 \text{ rounded to } \underline{\$43,700}$$

Problem 2.32.

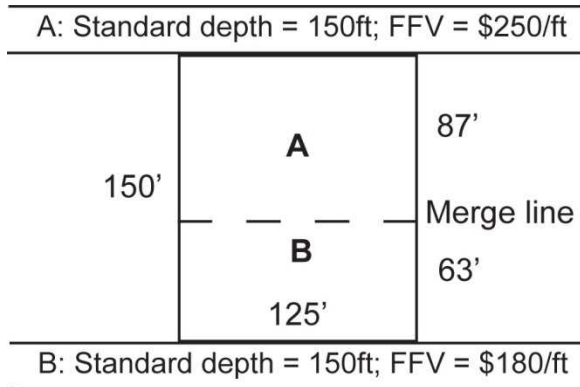

Merge line:

a) $FFV_{TOTAL} = FFV_A + FFV_B = \$250/ft + \$180/ft = 430$

b) Merge factor (MF) = Parcel depth/ $FFV_{TOTAL} = 150ft/430 = 0.35$

c) Merge line_A = $FFV_A \times MF = \$250/ft \times 0.35 = 87$.

Merge line_B = $FFV_B \times MF = \$180/ft \times 0.35 = 63$.

Value of Lot A:

1) $DF = \sqrt{(\text{lot depth}/\text{standard depth})} = \sqrt{(87ft/150ft)} = \sqrt{0.58} = 0.76$

2) Value_A = $FFV \times DF \times FF = \$250/ft \times 0.76 \times 125ft = \underline{\$23,750}$

Value of Lot B:

1) $DF = \sqrt{(\text{lot depth}/\text{standard depth})} = \sqrt{(63ft/150ft)} = \sqrt{0.42} = 0.65$

2) Value_B = $FFV \times DF \times FF = \$180/ft \times 0.65 \times 125ft = \underline{\$14,625}$

Parcel Value = Lot Value_A + Lot Value_B = $\$23,750 + \$14,625 = \$38,375$ rounded to $\$38,400$

Problem 2.33.

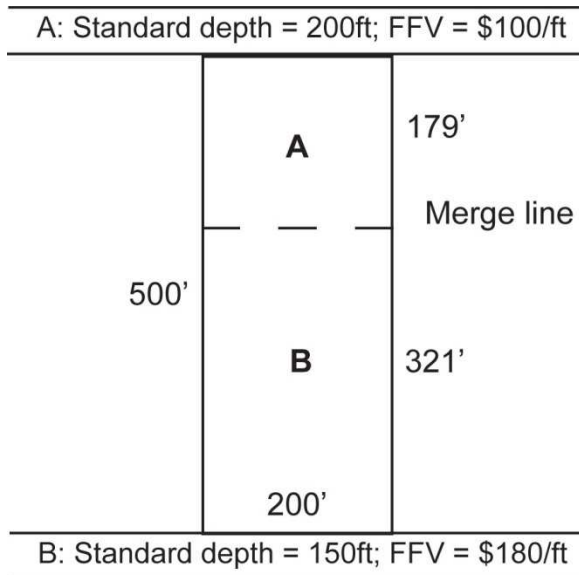

Merge line:

a) $FFV_{TOTAL} = FFV_A + FFV_B = \$100/ft + \$180/ft = 280$

b) Merge factor (MF) = Parcel depth/FFV_{TOTAL} = 500ft/280 = 1.79

c) Merge line_A = FFV_A x MF = \$100/ft x 1.79 = 179.

Merge line_B = FFV_B x MF = \$180/ft x 1.79 = 321.

Value of Lot A:

1) $DF = \sqrt{(\text{lot depth}/\text{standard depth})} = \sqrt{(179\text{ft}/200\text{ft})} = \sqrt{0.90} = 0.95$

2) $\text{Value}_A = FFV \times DF \times FF = \$100/\text{ft} \times 0.95 \times 200\text{ft} = \underline{\$19,000}$

Value of Lot B:

1) $DF = \sqrt{(\text{lot depth}/\text{standard depth})} = \sqrt{(321\text{ft}/150\text{ft})} = \sqrt{2.14} = 1.46$

2) $\text{Value}_B = FFV \times DF \times FF = \$180/\text{ft} \times 1.46 \times 200\text{ft} = \underline{\$52,560}$

Parcel Value = Lot Value_A + Lot Value_B = \$19,000 + \$52,560 = \$71,560 rounded to \$71,600

Problem 2.34.

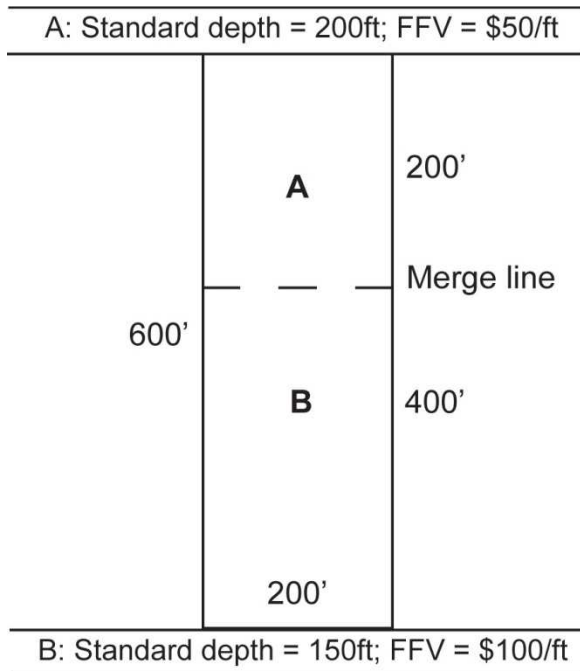

Merge line:

a) $FFV_{TOTAL} = FFV_A + FFV_B = \$50/ft + \$100/ft = 150$

b) Merge factor (MF) = Parcel depth/ $FFV_{TOTAL} = 600ft/150 = 4.00$

c) Merge line_A = $FFV_A \times MF = \$50/ft \times 4.00 = 200$.

Merge line_B = $FFV_B \times MF = \$100/ft \times 4.00 = 400$.

Value of Lot A:

1) $DF = \sqrt{(\text{lot depth}/\text{standard depth})} = \sqrt{(200ft/200ft)} = \sqrt{1.00} = 1.00$

2) $Value_A = FFV \times DF \times FF = \$50/ft \times 1.00 \times 200ft = \underline{\$10,000}$

Value of Lot B:

1) $DF = \sqrt{(\text{lot depth}/\text{standard depth})} = \sqrt{(400ft/150ft)} = \sqrt{2.67} = 1.63$

2) $Value_B = FFV \times DF \times FF = \$100/ft \times 1.63 \times 200ft = \underline{\$32,600}$

Parcel Value = Lot Value_A + Lot Value_B = $\$10,000 + \$32,600 = \underline{\$42,600}$

Problem 2.35.

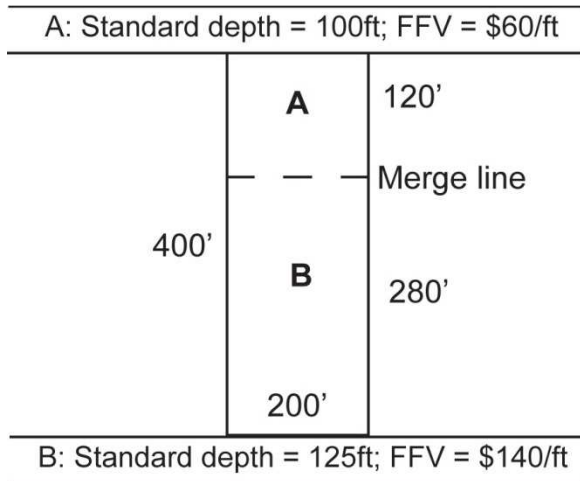

Merge line:

a) $FFV_{TOTAL} = FFV_A + FFV_B = \$60/ft + \$140/ft = 200$

b) Merge factor (MF) = Parcel depth/ $FFV_{TOTAL} = 400ft/200 = 2.00$

c) Merge line_A = $FFV_A \times MF = \$60/ft \times 2.00 = 120$.

Merge line_B = $FFV_B \times MF = \$140/ft \times 2.00 = 280$.

Value of Lot A:

1) $DF = \sqrt{(\text{lot depth}/\text{standard depth})} = \sqrt{(120ft/100ft)} = \sqrt{1.20} = 1.10$

2) $Value_A = FFV \times DF \times FF = \$60/ft \times 1.10 \times 200ft = \underline{\$13,200}$

Value of Lot B:

1) $DF = \sqrt{(\text{lot depth}/\text{standard depth})} = \sqrt{(280ft/125ft)} = \sqrt{2.24} = 1.50$

2) $Value_B = FFV \times DF \times FF = \$140/ft \times 1.50 \times 200ft = \underline{\$42,000}$

Parcel Value = Lot Value_A + Lot Value_B = $\$13,200 + \$42,000 = \underline{\$55,200}$

Problem 2.42

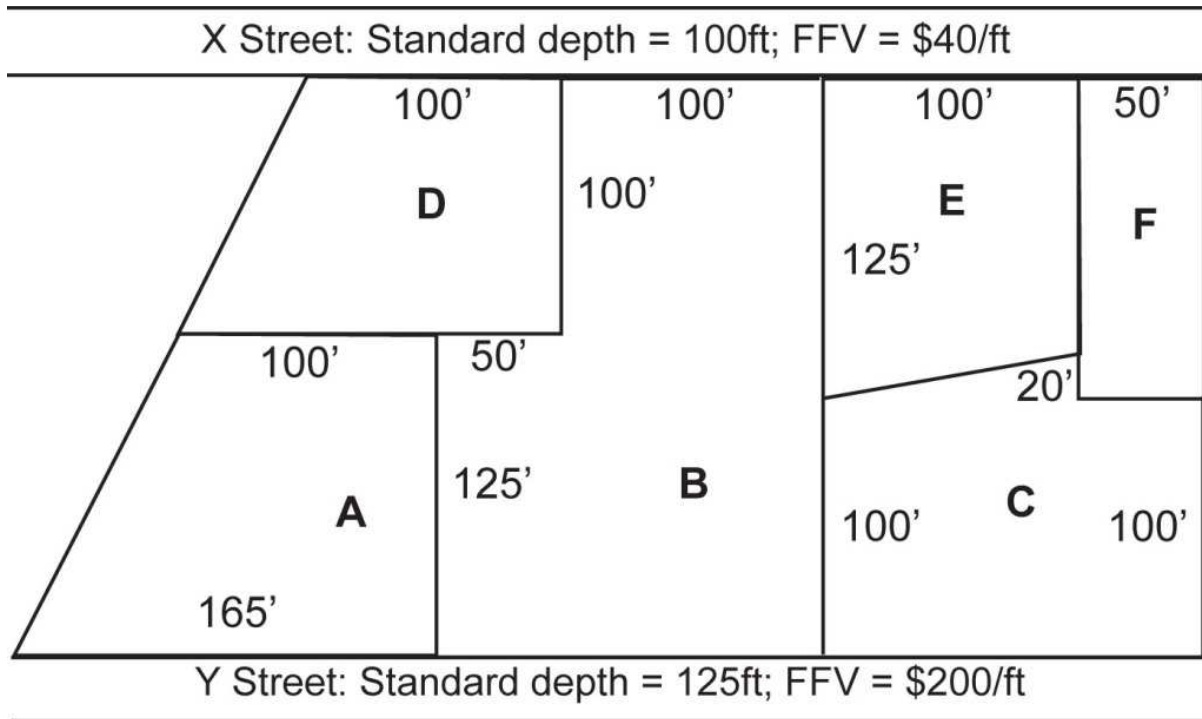

Parcel A: (oblique trapezoid – rectangle and delta triangle)

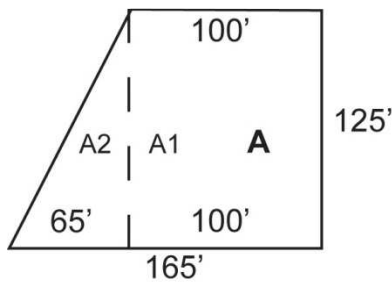

$$DF = \sqrt{125\text{ft}/125\text{ft}} = \sqrt{1.00} = 1.00, \text{ TF} = 0.60$$

$$A_1: \text{Value} = \$200/\text{ft} \times 1.00 \times 100\text{ft} = \underline{\$20,000}$$

$$A_2: \text{Value} = \$200/\text{ft} \times 1.00 \times 65\text{ft} \times 0.60 = \underline{\$7,800}$$

$$\text{Parcel A Value} = \$20,000 + \$7,800 = \underline{\$27,800}$$

Parcel B: (odd shape – rectangle and parcel with frontage on two streets)

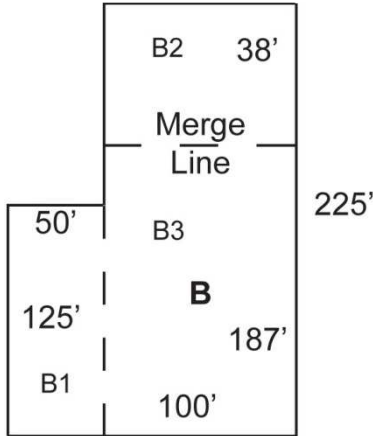

B₁: $DF_{B1} = \sqrt{(125\text{ft}/125\text{ft})} = \sqrt{1.00} = 1.00$
 Value = $\$200/\text{ft} \times 1.00 \times 50\text{ft} = \underline{\$10,000}$

B₂: $ML_{B2} = \$40/\text{ft} \times (225\text{ft}/(\$40/\text{ft} + \$200/\text{ft}))$
 $= \$40/\text{ft} \times (225\text{ft}/\$240/\text{ft}) = \$40/\text{ft} \times 0.9375\text{ft}^2/\$$
 $= 37.5\text{ft}$ rounded up to 38ft
 $DF_{B2} = \sqrt{(38\text{ft}/100\text{ft})} = \sqrt{0.38} = 0.62$
 Value = $\$40/\text{ft} \times 0.62 \times 100\text{ft} = \underline{\$2,480}$

B₃: $ML_{B3} = \$200/\text{ft} \times (225\text{ft}/(\$200/\text{ft} + \$40/\text{ft}))$
 $= \$200/\text{ft} \times 0.9375\text{ft}^2/\$ = 187.5\text{ft}$ rounded down to 187ft
 (rounded down to make $ML_{B2} + ML_{B3} =$ parcel depth)
 $DF_{B3} = \sqrt{(187\text{ft}/125\text{ft})} = \sqrt{1.50} = 1.22$
 Value = $\$200/\text{ft} \times 1.22 \times 100\text{ft} = \underline{\$24,400}$

Parcel B Value = $\$10,000 + \$2,480 + \$24,400 = \$36,880$ rounded to $\$36,900$

Parcel C: (odd shape – rectangle and perpendicular trapezoid)

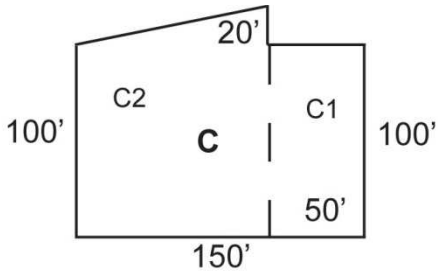

C₁: $DF_{C1} = \sqrt{(100\text{ft}/125\text{ft})} = \sqrt{0.80} = 0.89$
 Value = $\$200/\text{ft} \times 0.89 \times 50\text{ft} = \underline{\$8,900}$

C₂: Average depth = $(100\text{ft} + 120\text{ft})/2 = 110\text{ft}$
 $DF_{C2} = \sqrt{(110\text{ft}/125\text{ft})} = \sqrt{0.88} = 0.94$
 Value = $\$200/\text{ft} \times 0.94 \times 100\text{ft} = \underline{\$18,800}$

Parcel C Value = $\$8,900 + \$18,800 = \underline{\$27,700}$

Parcel D: (oblique trapezoid – rectangle and oblique trapezoid)

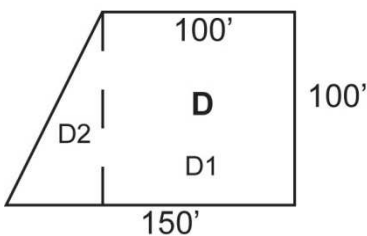

$DF = \sqrt{(100\text{ft}/100\text{ft})} = \sqrt{1.00} = 1.00$; $TF = 0.30$

D₁: Value = $\$40/\text{ft} \times 1.00 \times 100\text{ft} = \underline{\$4,000}$

D₂: Value = $\$40/\text{ft} \times 1.00 \times 50\text{ft} \times 0.30$
 $= \underline{\$600}$

Parcel D Value = $\$4,000 + \$600 = \underline{\$4,600}$

Parcel E: (perpendicular trapezoid)

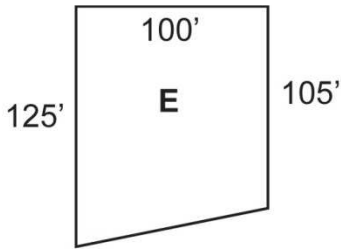

$$\text{Average depth} = (125\text{ft} + 105\text{ft})/2 = 115\text{ft}$$

$$DF = \sqrt{(115\text{ft}/100\text{ft})} = \sqrt{1.15} = 1.07$$

$$\text{Parcel E Value} = \$40/\text{ft} \times 1.07 \times 100\text{ft} = \underline{\underline{\$4,280}}$$

Parcel F: (rectangle)

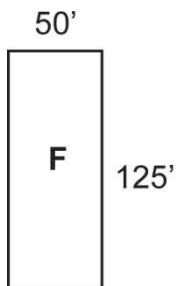

$$DF = \sqrt{(125\text{ft}/100\text{ft})} = \sqrt{1.25} = 1.12$$

$$\text{Parcel F Value} = \$40/\text{ft} \times 1.12 \times 50\text{ft} = \underline{\underline{\$2,240}}$$

Problem 2.43

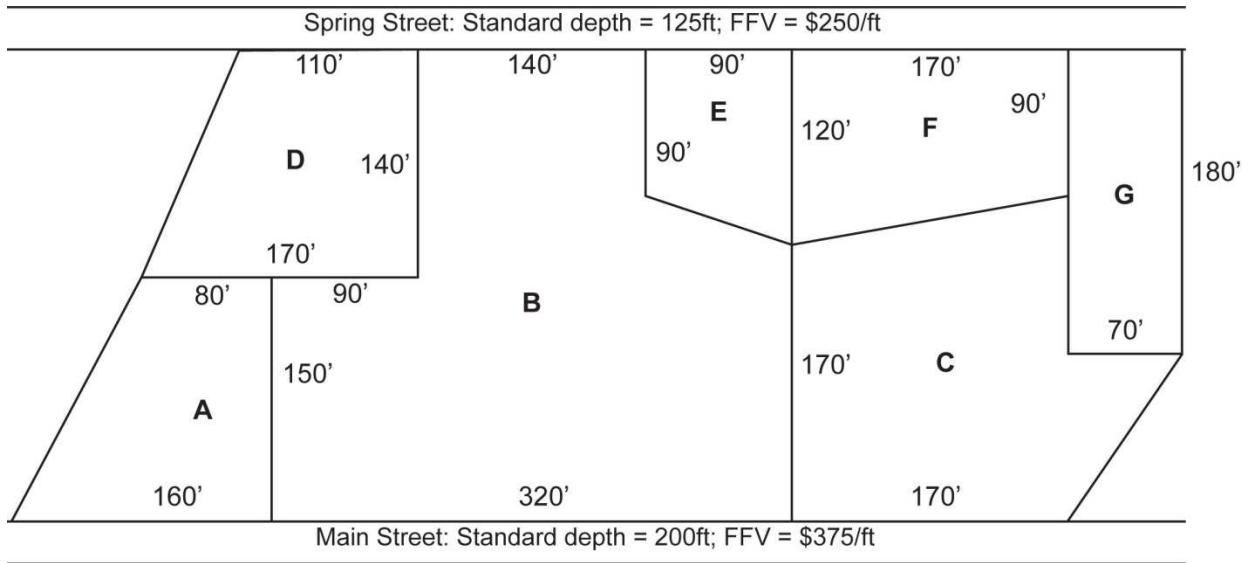

Parcel A: (oblique trapezoid with delta triangle)

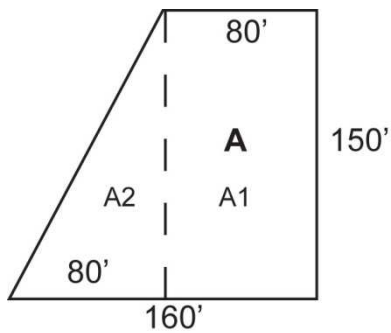

$$DF = \sqrt{(150\text{ft}/200\text{ft})} = \sqrt{0.75} = 0.87$$

$$A_1: \text{Value} = \$375/\text{ft} \times 0.87 \times 80\text{ft} = \underline{\$26,100}$$

$$A_2: \text{Value} = \$375 \times 0.87 \times 80\text{ft} \times 0.60 = \underline{\$15,660}$$

$$\text{Parcel A Value} = \$26,100 + \$15,660 = \$41,760 \text{ rounded to } \underline{\$41,800}$$

Parcel B: (odd shape – rectangle, perpendicular trapezoid and parcel on two streets)

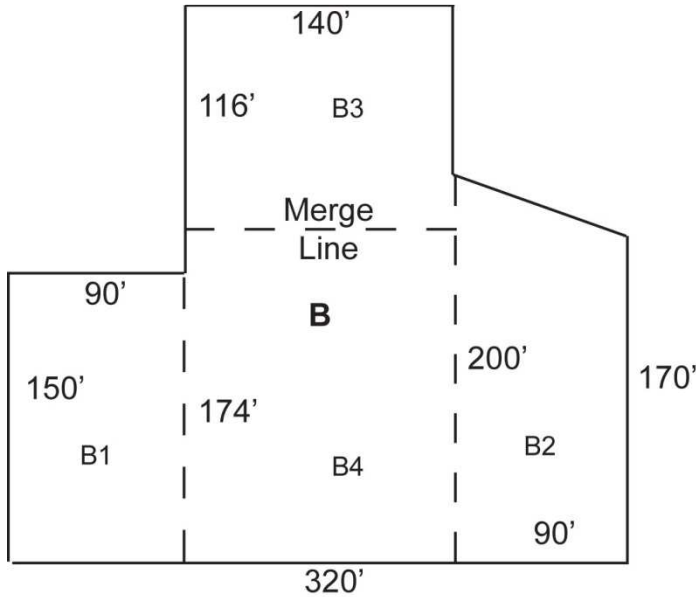

$$\begin{aligned} B_1: \quad DF &= \sqrt{(150\text{ft}/200\text{ft})} = \\ &= \sqrt{0.75} \\ &= 0.87 \\ \text{Value} &= \$375/\text{ft} \times 0.87 \times 90\text{ft} \\ &= \underline{\$29,362.50} \end{aligned}$$

$$\begin{aligned} B_2: \quad \text{Average depth} &= (200\text{ft} + 170\text{ft})/2 = 185\text{ft} \\ DF &= \sqrt{(185\text{ft}/200\text{ft})} = \sqrt{0.93} \\ &= 0.96 \\ \text{Value} &= \$375/\text{ft} \times 0.96 \times 90\text{ft} \\ &= \underline{\$32,400} \end{aligned}$$

$$\begin{aligned} B_3: \quad \text{ML} &= \$250/\text{ft} \times \\ &= (290\text{ft}/(\$250/\text{ft}) \\ &+ \$375/\text{ft}) \end{aligned}$$

$$\begin{aligned} &= \$250/\text{ft} \times 0.464\text{ft}^2/\$ = 116\text{ft} \\ DF &= \sqrt{(116\text{ft}/125\text{ft})} = \sqrt{0.93} \end{aligned}$$

$$= 0.96$$

$$\text{Value} = \$250/\text{ft} \times 0.96 \times 140\text{ft} = \underline{\$33,600}$$

$$\begin{aligned} B_4: \quad \text{ML} &= \$375/\text{ft} \times 0.464\text{ft}^2/\$ = 174\text{ft} \\ DF &= \sqrt{(174\text{ft}/200\text{ft})} = \sqrt{0.87} = 0.93 \\ \text{Value} &= \$375/\text{ft} \times 0.93 \times 140\text{ft} = \underline{\$48,825} \end{aligned}$$

Parcel B Value = \$29,362.50 + \$32,400 + \$33,600 + \$48,825 = \$144,187.50 rounded to \$144,200

Parcel C: (odd shape – perpendicular trapezoid and nabla triangle)

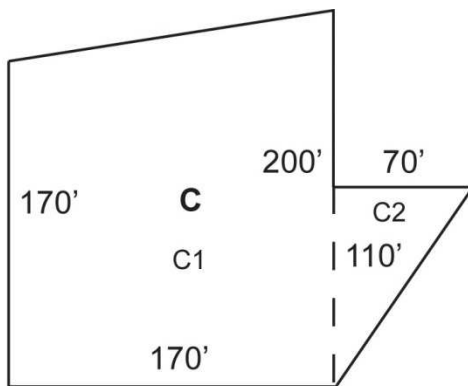

$$\begin{aligned} C_1: \quad \text{Average depth} &= (200\text{ft} + 170\text{ft})/2 = 185\text{ft} \\ DF &= \sqrt{(185\text{ft}/200\text{ft})} = \sqrt{0.93} = 0.96 \\ \text{Value} &= \$375/\text{ft} \times 0.96 \times 170\text{ft} \\ &= \underline{\$61,200} \end{aligned}$$

$$\begin{aligned} C_2: \quad DF &= \sqrt{(110\text{ft}/200\text{ft})} = \sqrt{0.55} = 0.74 \\ \text{Value} &= \$375/\text{ft} \times 0.74 \times 70\text{ft} \times 0.30 \\ &= \underline{\$5,827.50} \end{aligned}$$

Parcel C Value = \$61,200 + \$5,827.50 = \$67,027.50 rounded to \$67,000

Parcel D: (oblique trapezoid – rectangle and nabla triangle)

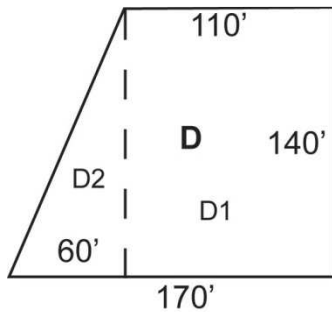

$$DF = \sqrt{(140\text{ft}/125\text{ft})} = \sqrt{1.12} = 1.06$$

$$D1: \quad \text{Value} = \$250/\text{ft} \times 1.06 \times 110\text{ft} = \underline{\$29,150}$$

$$D2: \quad \text{Value} = \$250/\text{ft} \times 1.06 \times 60\text{ft} \times 0.30 \\ = \underline{\$4,770}$$

$$\text{Parcel D Value} = \$29,150 + \$4,770 \\ = \$33,920 \text{ rounded to } \underline{\$33,900}$$

Parcel E: (perpendicular trapezoid)

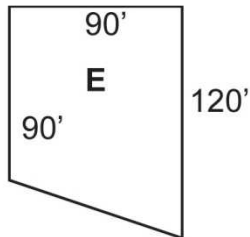

$$\text{Average depth} = (120\text{ft} + 90\text{ft})/2 = 105\text{ft}$$

$$DF = \sqrt{(105\text{ft}/125\text{ft})} = \sqrt{0.84} = 0.92$$

$$\text{Value} = \$250/\text{ft} \times 0.92 \times 90\text{ft} = \underline{\$20,700}$$

Parcel F: (perpendicular trapezoid)

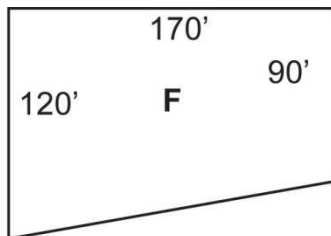

$$\text{Average depth} = (120\text{ft} + 90\text{ft})/2 = 105\text{ft}$$

$$DF = \sqrt{(105\text{ft}/125\text{ft})} = \sqrt{0.84} = 0.92$$

$$\text{Value} = \$250 \times 0.92 \times 170\text{ft} = \underline{\$39,100}$$

Parcel G: (rectangle)

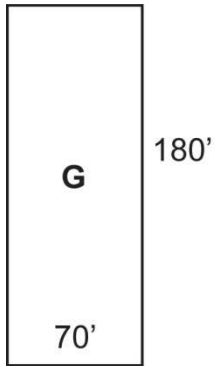

$$DF = \sqrt{(180\text{ft}/125\text{ft})} = \sqrt{1.44} = 1.20$$

$$\text{Value} = \$250/\text{ft} \times 1.20 \times 70\text{ft} = \underline{\underline{\$21,000}}$$

Problem 2.44

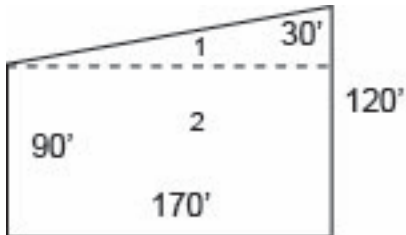

$$\begin{aligned} \text{Area}_1 &= \frac{1}{2} \times \text{length} \times \text{width} = \frac{1}{2} \times 170' \times 30' \\ &= \underline{\underline{2,550 \text{ sq ft}}} \end{aligned}$$

$$\text{Area}_2 = \text{length} \times \text{width} = 170' \times 90' = \underline{\underline{15,300 \text{ sq ft}}}$$

$$\begin{aligned} \text{Area} &= \text{Area}_1 + \text{Area}_2 = 2,550 \text{ sq ft} + 15,300 \text{ sq ft} \\ &= \underline{\underline{17,850 \text{ sq ft}}} \end{aligned}$$

Chapter 3 - Answers

3.1. A one-story ranch of wood frame construction on a full foundation with basement. The rear wall is 40 feet, the left side wall is 28 feet and the right-side wall is 24 feet. There is a front extension that is 4' x 12' and to the right of this is a 4' x 28' open porch. Attached to the right side of the house is a 24' x 24' garage. Attached to the back-right corner of the garage is a 12' x 12' wood deck (plat).

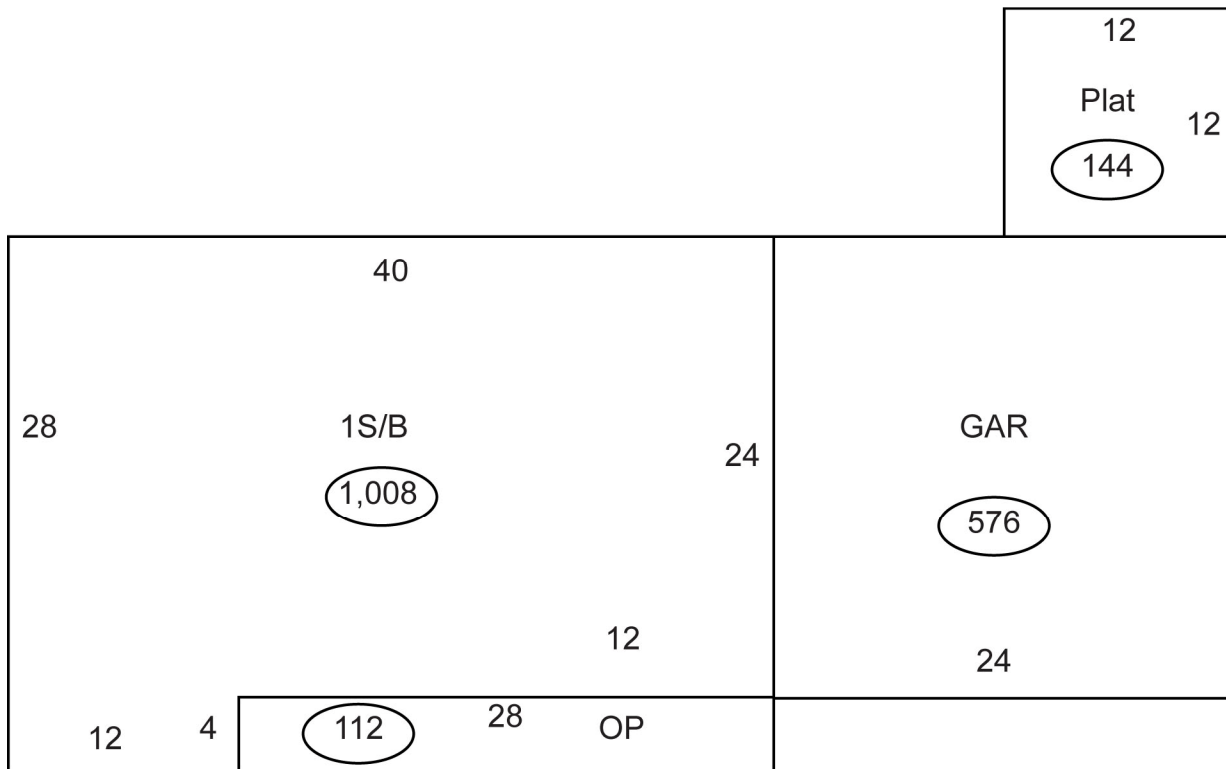

3.2. A one and three-quarter story cape style wood frame dwelling on a full foundation with basement. It measures 26' x 34', with 34' front and rear walls. Attached to the left side of the dwelling is a 12' x 14' one story addition on a foundation with a crawlspace. The 12' section runs along the left wall of the dwelling, beginning at the rear corner. Attached to the addition is a 12' x 14' shed on posts, with its 12' dimension running along, and even with, the left wall of the addition. Attached to the left side of the shed is a 28' x 36' barn with a loft, built on wood posts. The right front corner of the barn is even with the left front corner of the shed. The front of the barn is 28'.

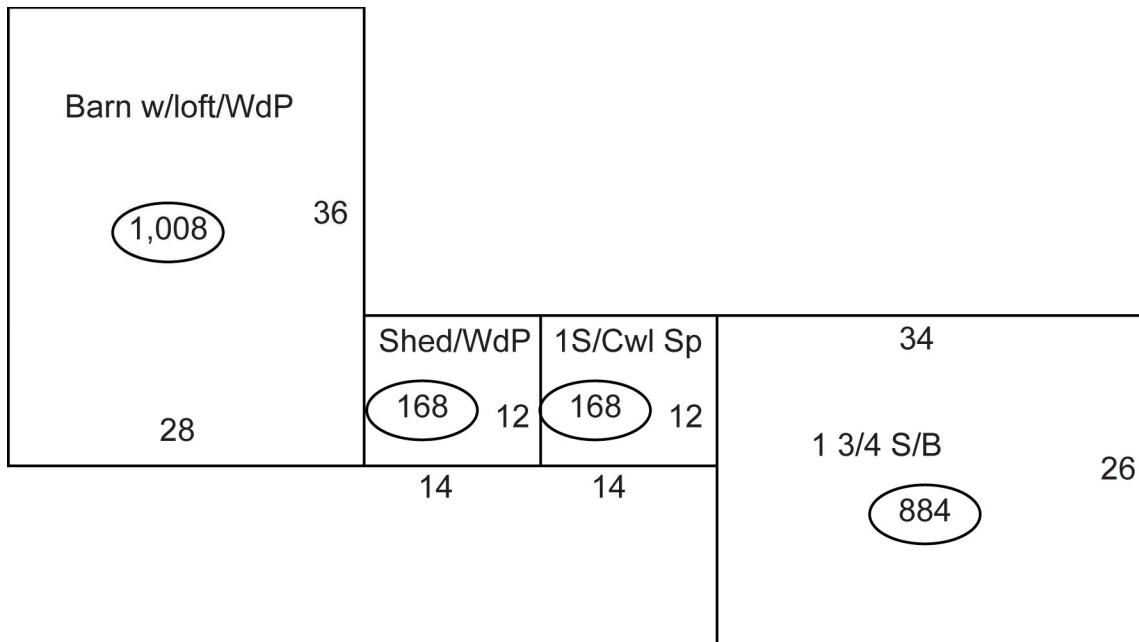

Class Problem 3.3. The following is the description of a 1 ½ story wood frame dwelling with 960 SF on the main level. Calculate the grade of each component and the final total grade.

1. Foundation: **Grade: 3.2**
 6'6" excavation – grade: 3; 8x18 footing – grade: 3; 8" poured concrete walls – grade: 4; outside drainage – grade: 3; waterproofed – grade: 3.

Average grade = $16/5 = 3.2$

2. Basement: **Grade: 3.0**
 6'6" depth – grade: 3; 6" gravel base and 3" concrete floor – grade: 3; no finished rooms – grade: 3.

Average grade = $9/3 = 3$

3. Framing:

Grade: 3.3

2x8x16oc floor joists – grade: 3; 2x6x16oc studs – grade: 4; 2x6x16oc rafters – grade: 3; 2x8x16oc ceiling joists – grade: 4; 2x4x24oc interior partitions – grade: 2.5.

Average grade = $16.5/5 = 3.3$

4. Roof:

Grade: 3.3

5/8 CDX plywood – grade: 3; 235lb asphalt cover – grade: 3; drip edge & boxed cornice – grade: 4.

Average grade = $10/3 = 3.33$

5. Interior:

Grade: 3.4

½ drywall – grade: 3; hardwood kitchen cabinets – grade: 4; softwood trim – grade: 3; interior panel doors – grade: 4; small closets – grade: 3.

Average grade = $17/5 = 3.4$

6. Exterior:

Grade: 3.6

5/8 CDX plywood – grade: 4; vinyl siding – grade: 3; builders grade DH windows – grade: 3, 6" insulation – grade: 4; 2 solid core exterior doors & 2 storm doors – grade: 4.

Average grade = $18/5 = 3.6$

7. Floors:

Grade: 3.3

½ plywood – grade: 3.5; 32oz carpeting & linoleum – grade: 3.

Average grade = $6.5/2 = 3.25$

8. Heating:

Grade: 3.0

Forced hot air (with returns) – grade: 3.

9. Plumbing:

Grade: 3.0

3pc average fixtures – grade: 3.

10. Electrical:

Grade: 3.0

100 amp panel – grade: 3; average fixtures & quality – grade: 3.

Average grade = $6/2 = 3.0$

$$\text{Total grade} = (3.2 + 3.0 + 3.3 + 3.3 + 3.4 + 3.6 + 3.3 + 3.0 + 3.0 + 3.0)/10 = 3.21$$

Total Grade (rounded): 3.2

Class Problem 3.4 The following is the description of a 2-story wood frame dwelling with 884 SF on the main level. Calculate the grade of each component and the final total grade.

1. Foundation: Grade: 4.0

8' excavation – grade: 4; 12x24 footing – grade: 4; 8" poured concrete walls, insulated and waterproofed – grade: 4; drainage on 2 sides – grade: 4; good site work – grade: 4.

$$\text{Average grade} = 20/5 = 4$$

2. Basement: Grade: 4.8

7'6" depth – grade: 5; 6" gravel base & 5" concrete floor smooth finish – grade: 4; finished rec room – grade: 5; built-in storage – grade: 5.

$$\text{Average grade} = 19/4 = 4.75$$

3. Framing: Grade: 4.5

2x12x16oc floor joists – grade: 5; 2x6x16oc studs – grade: 4.5; 2x10x16oc rafters – grade: 5; 2x8x16oc ceiling joists – grade: 4; 2x4x16oc interior partitions – grade: 4.

$$\text{Average grade} = 22.5/5 = 4.5$$

4. Roof: Grade: 4.0

T&G boards – grade: 4; wood shingles – grade: 4.5; drip edge & boxed cornice – grade: 3.5.

$$\text{Average grade} = 12/3 = 4$$

5. Interior: Grade: 4.5

5/8 drywall – grade: 4; hardwood kitchen cabinets – grade: 4; hardwood trim – grade: 4; raised panel interior doors – grade: 5; oak stairs – grade: 5; built-in cabinets – grade: 5.

$$\text{Average grade} = 27/6 = 4.5$$

6. Exterior:

Grade: 4.1

5/8 CDX plywood – grade: 4; custom cedar shingles – grade: 4; good quality DH windows – grade: 4.5; 6” insulation – grade: 4; 2 exterior raised panel doors & 2 storm doors – grade: 4.

$$\text{Average grade} = 20.5/5 = 4.1$$

7. Floors:

Grade: 4.5

3/4 plywood – grade: 5; 32oz carpet & hardwood & tile – grade: 4.

$$\text{Average grade} = 9/2 = 4.5$$

8. Heating:

Grade: 4.0

Hot water radiant.

9. Plumbing:

Grade: 4.0

3pc good fixtures.

10. Electrical

Grade: 4.5

200 amp panel – grade: 4.5; recessed lighting – grade: 4.5; wired for data & cable – grade: 4.5.

$$\text{Average grade} = 13.5/3 = 4.5$$

$$\text{Total grade} = (4.0 + 4.8 + 4.5 + 4.0 + 4.5 + 4.1 + 4.5 + 4.0 + 4.0 + 4.5)/10 = 4.29$$

Total Grade (rounded): 4.3

Chapter 4 - Answers

Class Problem 4.1. Find the perimeter of this L-shaped building.

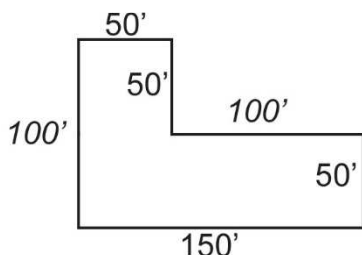

$$\begin{aligned} \text{Perimeter} &= 50' + 50' + 100' + 50' + 150' + 100' \\ &= 500' \end{aligned}$$

Class problem 4.2. Calculate the value of the property described below. Your final value estimate should include the replacement cost of all improvements less depreciation and functional obsolescence.

The dwelling is a one-story ranch house measuring 30' x 40'. The assessor has given the house a grade of 3.5. The house has an enclosed porch measuring 25' x 6', also a grade 3.5. The house has a finished basement and a 350-square-foot paved driveway, each with a grade of 3.0. Included in the sale are a range and oven and a dishwasher, each a grade 3.0.

All improvements are in average overall condition, with an estimated depreciation of 20%. Functional obsolescence is estimated at 7%. No external obsolescence is present.

Dwelling:

Area = 30' x 40' = 1,200 sq ft

Difference between grade 3 and grade 4 for 1,200 sq ft, 1-story dwelling:

\$ 54,200

Percent difference between grades 3 and 4 for the dwelling:

x 0.50

Cost difference:

\$ 27,100

Cost for 1-story, 1,200 sq ft dwelling, grade 3:

+ \$ 119,670

Total dwelling cost:

\$146,770

Enclosed porch:

Area = 25' x 6' = 150 sq ft

Difference between grade 3 and grade 4 for 150 sq ft

enclosed porch (\$12,840 – \$8,960)

\$ 3,880

Percent difference between grades 3 and 4 for the porch:

x 0.50

Cost difference:

\$ 1,940

Cost for 150 sq ft enclosed porch, grade 3:

+ \$ 8,960

Total porch cost:

\$ 10,900

Finished basement:

Area in square feet (same as dwelling):	1,200
Cost per square foot, grade 3:	x \$ <u>17.50</u>
Total amenities cost:	\$ 21,000

Paved driveway:

Area in square feet:	350
Cost per square foot:	\$ <u>2.80</u>
Total driveway cost:	\$ 980

Appliances:

Range and oven:	\$ 1,100
Dishwasher:	\$ <u>760</u>
Total appliance cost:	\$ 1,860

Total property replacement cost new (RCN):

Dwelling cost:	\$146,770
Enclosed porch cost:	\$ 10,900
Finished basement cost:	\$ 21,000
Paved driveway cost:	\$ 980
Appliances cost:	\$ <u>1,860</u>
Total property RCN:	<u>\$181,510</u>

Depreciation:

RCN:	\$181,510
Depreciation percentage (25%):	x <u>0.20</u>
Total depreciation:	\$ 36,302

Functional obsolescence:

RCN:	\$181,510
Depreciation:	- \$ 36,302
RCN less depreciation:	\$145,208
Functional obsolescence percentage (5%):	x <u>0.07</u>
Total functional obsolescence:	\$ 10,165

Total value of property:

Total property RCN:	\$181,510
Total depreciation:	- \$ 36,302
Total functional obsolescence:	- \$ <u>10,165</u>
Property value:	<u>\$135,043</u>

Chapter 5 - Answers

Problem 5.1: Comparative Market Analysis

Determine, using the data below and your own judgment, the value of the following subject property.

The subject property and all three comparables are located in the same area. All four properties are connected to public water and sewer and they all have typical sized parcels.

Subject: Located on a secondary street with typical appeal. The house is a 22 year old ranch, 1,040 square feet in area, with recent updates, and is in good condition. It has a full basement that is 50% finished. Amenities include an open porch in the front, a deck in back and a one-car garage.

Comparable 1: Sold for \$159,900, this house is located on a secondary street with typical appeal. The house is a 28 year old ranch, 960 square feet in area, in average condition. It has a full basement that is completely finished. Amenities include a deck in back.

Comparable 2: Sold for \$178,000, this house is located on a secondary street with typical appeal. The house is a 20 year old ranch, 1,144 square feet in area, with recent updates, and is in good condition. It has a full basement that is unfinished. Amenities include an enclosed porch in the front, a deck in back and a one-car garage.

Comparable 3: Sold for \$195,000, this house is located on a secondary street with better than average appeal. The house is a 20 year old ranch, 1,232 square feet in area, with recent updates and is in good condition. It has a full basement that is 25% finished. Amenities include an open porch in the front, a deck in back and a two-car garage.

Paired sales analyses have determined the following characteristic values.

- \$5,000 for a good location
- \$7,500 for an age/condition adjustment;
- \$35/sf for difference in area
- \$1,500 for a 25% finished basement
- \$3,000 for a 50% finished basement
- \$4,500 for a 75% finished basement
- \$6,000 for a fully finished basement
- \$4,000 for an enclosed porch
- \$2,500 for an open porch

Answers to Class Problems – Chapter 5

\$1,500 for a deck
 \$5,000 for a one-car garage
 \$9,000 for a two-car garage

<u>Elements</u>	<u>Subject</u>	<u>Comp 1</u>	<u>Comp 2</u>	<u>Comp 3</u>
Sale Price	-----	\$159,900	\$178,000	\$195,000
Location/site Adjustment	Typical -----	Typical -----	Typical -----	Above avg (\$5,000)
Age/condition Adjustment	22yrs/good -----	28yrs/avg \$7,500	20yrs/good -----	20yrs/good -----
Size Adjustment	1,040sf -----	960sf \$2,800	1,144sf (\$3,640)	1,232sf (\$6,720)
Basement Adjustment	Full/50% -----	Full/100% (\$3,000)	Full/0% \$3,000	Full/25% \$1,500
Deck Adjustment	OP/Deck -----	Deck \$2,500	EP/Deck (\$1,500)	OP/Deck -----
Garage Adjustment	One-car -----	None \$5,000	One-car -----	Two-car (\$4,000)
# of Adjustments	-----	5	3	4
Net Adjustment	-----	\$ 14,800	(\$2,140)	(\$14,220)
Adjusted Sale Price	-----	\$174,700	\$175,860	\$180,780

Subject Value = \$176,000

Explanation: The adjusted price (rounded) for Comparable #2 is used for the subject property value because Comparable #2 had the fewest adjustments and the adjusted value fell between the adjusted values of the other two comparables, indicating a reliable estimate.

Calculations

Size adjustment: The adjustment for size differences is \$35/sf
 Comparable #1 is 80sf smaller than the subject (1,040sf – 960sf).
 Adjustment = 80sf x \$35/sf = \$2,800 addition because comparable is smaller.
 Comparable #2 is 104sf larger than the subject (1,144sf – 1,040sf).
 Adjustment = 104sf x \$35/sf = \$3,640 subtraction because comparable is larger.
 Comparable #3 is 192sf larger than the subject (1,232sf – 1,040sf).
 Adjustment = 192sf x \$35/sf = \$6,720 subtraction because comparable is larger.

Basement

adjustment: All basements are full. Finish values: \$1,500 for 25%; \$3,000 for 50%; \$4,500 for 75%; \$6,000 for 100%. Subject is 50% finished.
 Comparable #1 difference from subject =
 100% - 50% = \$6,000 - \$3,000 = \$3,000 subtraction because comparable is better.
 Comparable #2 difference from subject =
 0% - 50% = \$0 - \$3,000 = \$3,000 addition because comparable is not as good.
 Comparable #3 difference from subject =
 25% - 50% = \$1,500 - \$3,000 = \$1,500 addition because comparable is not as good.

Deck adjustment: Values: EP = \$4,000; OP = \$2,500; Deck = \$1,500. The subject has OP and Deck.
 Comparable #1 difference from subject = Deck – (OP + Deck)
 = OP = \$2,500 addition because comparable is not as good.
 Comparable #2 difference from subject = (EP + Deck) – (OP + Deck) = EP – OP = \$4,000 - \$2,500 = \$1,500 subtraction because comparable is better.

Garage adjustment: Values: One-car = \$5,000; Two-car = \$9,000. The subject has a one-car garage.
 Comparable #1 difference from subject = No garage – one-car garage = \$0 - \$5,000 = \$5,000 addition because comparable is not as good.
 Comparable #3 difference from subject = Two-car garage – one-car garage = \$9,000 - \$5,000 = \$4,000 subtraction because comparable is better.

Problem 5.2. Paired Sales Analysis.

Using the grid below, apply the paired sales analysis steps to adjust comparables to the subject property. What assessed value would you give to the subject property?

Hint: Compare Sales 2 & 5 for the deck, 1 & 5 for the garage, and 1 & 4 for the basement.

	Subject	Sale 1	Sale 2	Sale 3	Sale 4	Sale 5
Price	?	\$195,000	\$210,000	\$185,000	\$180,000	\$205,000
Deck	Yes	No	Yes	Yes	No	No
Adjusted Price		+\$5,000			+\$5,000	+\$5,000
Garage	1-car	1-car	2-car	1-car	1-car	2-car
Adjusted price			-\$10,000			-\$10,000
Basement	Full	Full	Full	Partial	Partial	Full
Adjusted Price				+\$15,000	+\$15,000	
Price after adj.		\$200,000	\$200,000	\$200,000	\$200,000	\$200,000

The subject property should be assessed at \$200,000.

Chapter 6 - Answers

Problem 6.1. Tony is considering buying an apartment building and wants to know what it is worth. He estimates his potential gross income to be \$150,000, miscellaneous income to be \$12,000, vacancy and collection loss of 5% of PGI and operating expenses of \$80,000. What is the estimated NOI for this property? If Tony's estimated capitalization rate is 6.7%, what is the value of the property?

PGI	\$150,000		
MI	\$ 12,000		
VCL	(\$ 7,500)	(\$150,000 x 0.05)	
OE	<u>(\$ 80,000)</u>		
NOI	\$ 74,500		

$$V = I/R = \$74,500/0.067 = \$1,111,940$$

Problem 6.2. Tony, from Problem 6.1, realizes that the capitalization rate he used to determine the apartment building value only included the interest rate of 4% and the building recapture rate of 2.7%. If the local property tax rate is 20 mills and the municipality declares a 100% certified ratio, what are the capitalization rates for land and for the improvements?

$$ETR = \text{mill rate} \times \text{certified ratio} = 20 \times 100\% = 20 \text{ or } 0.02$$

$$R_L = \text{interest} + ETR = 0.04 + 0.02 = 0.06 \text{ or } 6\%$$

$$R_B = \text{interest} + ETR + \text{recapture rate} = 0.04 + 0.02 + 0.027 = 0.087 \text{ or } 8.7\%$$

Problem 6.3. Bob, a developer, is planning to build an apartment building on a vacant parcel of land for sale. He wants to know if the project is a good investment. To determine this, he needs an estimate of the property value including the land and building. Bob has put together the following estimates:

$$PGI = \$35,000$$

$$MI = \$1,500$$

$$VCL = 3.5\% \text{ of PGI}$$

$$OE = \$8,750$$

$$\text{Sale price of land} = \$50,000$$

$$\text{Economic life of proposed building} = 40 \text{ years}$$

$$\text{Current mortgage interest rate} = 4.0\%$$

$$\text{Local tax rate} = 20 \text{ mills}$$

$$\text{Municipal certified ratio} = 90\%$$

1) What is the net operating income?

NOI =	PGI	\$35,000	
	+MI	\$ 1,500	
	-VCL	(\$ 1,225)	(\$35,000 x 0.035)
	-OE	<u>(\$ 8,750)</u>	
		<u>\$26,525</u>	

2) What is the effective tax rate?

$$\text{ETR} = \text{mill rate} \times \text{certified ratio} = 20 \text{ mills} \times 90\% = 0.02 \times 0.9 = 0.018$$

3) What is the recapture rate?

$$\text{Recapture rate} = 1/\text{economic life} = 1/40 = 0.025$$

4) What is the capitalization rate for the land?

$$R_L = \text{interest rate} + \text{ETR} = 0.04 + 0.018 = 0.058$$

5) What is the capitalization rate for the building?

$$R_B = \text{interest rate} + \text{ETR} + \text{recapture rate} = 0.04 + 0.018 + 0.025 = 0.083$$

6) What is the income attributable to the land?

$$I_L = R_L \times V_L = 0.058 \times \$50,000 = \$2,900$$

(the value of the land is equal to the sale price, \$50,000)

7) What is the income attributable to the building?

$$I_B = \text{NOI} - I_L = \$26,525 - \$2,900 = \$23,625$$

8) What is the total value of the property?

$$V = V_L + V_B = \$50,000 + (I_B/R_B) = \$50,000 + (\$23,625/0.083)$$

$$= \$50,000 + \$284,639 = \$334,639 \text{ or } \$335,000 \text{ rounded to the nearest } \$1,000$$

Answers to Class Problems – Chapter 6

	Income	Rate	Value
Land	\$2,900	0.058	\$50,000
Building	\$23,625	0.083	\$284,639
Total	\$35,000		\$334,639

Problem 6.4. Bob now wants to purchase an existing apartment building that is on the market for \$200,000. He wants to know if the property is a good investment. To determine this, he needs an estimate of the property value including the land and building. Bob has put together the following estimates:

$$\text{PGI} = \$25,000$$

$$\text{MI} = \$1,000$$

$$\text{VCL} = 3.5\% \text{ of PGI}$$

$$\text{OE} = \$5,000$$

$$\text{Estimated land value} = \$60,000$$

$$\text{Remaining economic life of building} = 20 \text{ years}$$

$$\text{Current mortgage interest rate} = 3.5\%$$

$$\text{Local tax rate} = 20 \text{ mills}$$

$$\text{Municipal certified ratio} = 90\%$$

Should Bob purchase this building? Hint: Follow the same series of questions from Problem 6.3.

1) What is the net operating income?

NOI =	PGI	\$25,000	
	+MI	\$ 1,000	
	-VCL	(\$ 875)	(\$25,000 x 0.035)
	-OE	<u>(\$ 5,000)</u>	
		<u>\$20,125</u>	

2) What is the effective tax rate?

$$\text{ETR} = \text{mill rate} \times \text{certified ratio} = 20 \text{ mills} \times 90\% = 0.02 \times 0.9 = 0.018$$

3) What is the recapture rate?

$$\text{Recapture rate} = 1/\text{economic life} = 1/20 = 0.050$$

4) What is the capitalization rate for the land?

$$R_L = \text{interest rate} + \text{ETR} = 0.035 + 0.018 = 0.053$$

5) What is the capitalization rate for the building?

$$R_B = \text{interest rate} + \text{ETR} + \text{recapture rate} = 0.035 + 0.018 + 0.050 = 0.103$$

6) What is the income attributable to the land?

$$I_L = R_L \times V_L = 0.053 \times \$60,000 = \$3,180$$

7) What is the income attributable to the building?

$$I_B = \text{NOI} - I_L = \$20,125 - \$3,180 = \$16,945$$

8) What is the total value of the property?

$$V = V_L + V_B = \$60,000 + (I_B/R_B) = \$60,000 + (\$16,945/0.103) \\ = \$60,000 + \$164,515 = \$224,515$$

	Income	Rate	Value
Land	\$3,180	0.053	\$60,000
Building	\$16,945	0.103	\$164,515
Total			\$224,515

Bob should purchase this building.

Problem 6.5. Bob, looking to expand his property holdings, wants to buy the 8-unit apartment building next door. The owner of the building is asking \$700,000 for it. Bob has put together the following estimates:

$$\text{PGI} = \$80,000$$

$$\text{MI} = \$6,000$$

$$\text{VCL} = 5\% \text{ of PGI}$$

$$\text{OE} = \$10,000$$

$$\text{Estimated land value} = \$50,000$$

$$\text{Remaining economic life of building} = 23 \text{ years}$$

$$\text{Current mortgage interest rate} = 4.2\%$$

$$\text{Local tax rate} = 20 \text{ mills}$$

$$\text{Municipal certified ratio} = 85\%$$

Should Bob make this investment?

1) What is the net operating income?

NOI =	PGI	\$80,000	
	+MI	\$ 6,000	
	-VCL	(\$ 4,000)	(\$80,000 x 0.050)
	-OE	<u>(\$10,000)</u>	
		<u>\$72,000</u>	

2) What is the effective tax rate?

$$\text{ETR} = \text{mill rate} \times \text{certified ratio} = 20 \text{ mills} \times 85\% = 0.02 \times 0.85 = 0.017$$

3) What is the recapture rate?

$$\text{Recapture rate} = 1/\text{economic life} = 1/23 = 0.043$$

4) What is the capitalization rate for the land?

$$R_L = \text{interest rate} + \text{ETR} = 0.042 + 0.017 = 0.059$$

5) What is the capitalization rate for the building?

$$R_B = \text{interest rate} + \text{ETR} + \text{recapture rate} = 0.042 + 0.017 + 0.043 = 0.102$$

6) What is the income attributable to the land?

$$I_L = R_L \times V_L = 0.059 \times \$50,000 = \$2,950$$

Answers to Class Problems – Chapter 6

7) What is the income attributable to the building?

$$I_B = \text{NOI} - I_L = \$72,000 - \$2,950 = \$69,050$$

8) What is the total value of the property?

$$V = V_L + V_B = \$50,000 + (I_B/R_B) = \$50,000 + (\$69,050/0.102) \\ = \$50,000 + \$676,961 = \$726,961$$

	Income	Rate	Value
Land	\$2,950	0.059	\$50,000
Building	\$69,050	0.102	\$676,961
Total			\$726,961

Bob should purchase this building.

Problem 6.6. Bob, still not satisfied, wants to build an even bigger apartment building on a vacant parcel of land for sale. He wants to know if the project is a good investment. To determine this, he needs an estimate of the property value including the land and building. Bob has put together the following estimates:

- PGI = \$100,000
- MI = \$6,000
- VCL = 5% of PGI
- OE = \$25,000
- Sale price of land = \$55,000
- Economic life of proposed building = 40 years
- Current mortgage interest rate = 4.5%
- Local tax rate = 18 mills
- Municipal certified ratio = 85%

What is the property value estimate, to the nearest \$1,000?

NOI =	PGI	\$100,000	
	+MI	\$ 6,000	
	-VCL	(\$ 5,000)	(\$100,000 x 0.050)
	-OE	<u>(\$ 25,000)</u>	
		<u>\$ 76,000</u>	

$$\text{ETR} = \text{mill rate} \times \text{certified ratio} = 18 \text{ mills} \times 85\% = 0.018 \times 0.85 = 0.015$$

$$\text{Recapture rate} = 1/\text{economic life} = 1/40 = 0.025$$

$$R_L = \text{interest rate} + \text{ETR} = 0.045 + 0.015 = 0.060$$

$$R_B = \text{interest rate} + \text{ETR} + \text{recapture rate} = 0.045 + 0.015 + 0.025 = 0.085$$

$$I_L = R_L \times V_L = 0.060 \times \$55,000 = \$3,300$$

$$I_B = \text{NOI} - I_L = \$76,000 - \$3,300 = \$72,700$$

$$\begin{aligned} V &= V_L + V_B = \$55,000 + (I_B/R_B) = \$55,000 + (\$72,700/0.085) \\ &= \$55,000 + \$855,294 = \$910,294 \text{ or } \$910,000 \end{aligned}$$

Answers to Class Problems – Chapter 6

	Income	Rate	Value
Land	\$3,300	0.060	\$55,000
Building	\$72,700	0.085	\$885,294
Total	\$76,000		\$910,294

Chapter 7 - Answers

Problem 7.1

ITEM NO.		CLASS	MO/YR		SALE PRICE	ASSESSMENT	RATIO	DEV.	
1		R	04/09		\$269,000	\$161,400	60%	27	
2		M	06/09		\$172,000	\$106,600	62%	25	
3		M	12/09		\$165,000	\$102,300	62%	25	Outliers
4		R	02/09		\$174,500	\$118,700	68%	19	
5		R	03/09		\$232,500	\$165,100	71%	16	
6		R	02/09		\$199,000	\$143,300	72%	15	
7	1	M	10/09		\$162,000	\$119,900	74%	13	
8	2	R	09/09		\$145,000	\$107,300	74%	13	
9	3	M	06/09		\$159,000	\$119,200	75%	12	
10	4	R	08/09		\$205,000	\$157,800	77%	10	
11	5	R	01/09		\$158,900	\$122,400	77%	10	
12	6	M	02/09		\$150,000	\$115,500	77%	10	
13	7	M	05/09		\$148,000	\$117,700	80%	7	
14	8	R	05/09		\$215,000	\$174,200	81%	6	
15	9	R	09/09		\$178,000	\$146,000	82%	5	
16	10	R	11/09		\$209,900	\$176,300	84%	3	
17	11	R	03/09		\$150,000	\$126,000	84%	3	
18	12	R	04/09		\$167,500	\$142,400	85%	2	
19	13	M	07/09		\$138,500	\$120,500	87%	0	Mean
20	14	R	04/09		\$239,000	\$207,900	87%	0	87%
21	15	M	11/09		\$145,000	\$127,600	88%	1	
22	16	R	10/09		\$244,000	\$219,600	90%	3	
23	17	R	03/09		\$177,700	\$159,900	90%	3	
24	18	M	08/09		\$142,000	\$129,200	91%	4	
25	19	R	02/09		\$180,000	\$163,800	91%	4	
26	20	R	07/09		\$224,500	\$206,500	92%	5	
27	21	M	05/09		\$135,000	\$126,900	94%	7	
28	22	R	10/09		\$149,000	\$140,000	94%	7	
29	23	R	01/09		\$192,500	\$182,900	95%	8	
30	24	M	11/09		\$139,900	\$132,900	95%	8	
31	25	R	05/09		\$136,500	\$129,700	95%	8	
32	26	R	08/09		\$188,000	\$184,200	98%	11	
33	27	M	04/09		\$147,000	\$145,500	99%	12	
34	28	M	04/09		\$132,600	\$132,700	100%	13	2436
35		R	07/09		\$184,500	\$188,200	102%	15	
36		R	12/09		\$156,600	\$164,400	105%	18	
37		M	10/09		\$139,000	\$150,100	108%	21	Outliers
38		R	08/09		\$125,000	\$137,500	110%	23	
39		M	09/09		\$125,000	\$140,100	112%	25	
40		R	12/09		\$149,000	\$177,300	119%	32	
				Totals:	\$6,850,600	\$5,889,500		449	
Weighted Average Ratio:				$5889500 \div 6850600$		86%			
Average Ratio:				$2436 \div 28$		87			
Average Deviation:				$449 \div 40$		11.2			
Quality Rating:				$11.2 \div 87$		13			

Answers to Class Problems – Chapter 7

Problem 7.2

ITEM NO.		CLASS	MO/YR		SALE PRICE	ASSESSMENT	RATIO	DEV.	
1		M	06/09		\$172,000	\$106,600	62%	25	Outliers
2		M	12/09		\$165,000	\$102,300	62%	25	
3	1	M	10/09		\$162,000	\$119,900	74%	13	
4	2	M	06/09		\$159,000	\$119,200	75%	12	
5	3	M	02/09		\$150,000	\$115,500	77%	10	
6	4	M	05/09		\$148,000	\$117,700	80%	7	
7	5	M	07/09		\$138,500	\$120,500	87%	0	Mean
8	6	M	11/09		\$145,000	\$127,600	88%	1	87%
9	7	M	08/09		\$142,000	\$129,200	91%	4	
10	8	M	05/09		\$135,000	\$126,900	94%	7	
11	9	M	11/09		\$139,900	\$132,900	95%	8	
12	10	M	04/09		\$147,000	\$145,500	99%	12	
13	11	M	04/09		\$132,600	\$132,700	100%	13	960
14		M	10/09		\$139,000	\$150,100	108%	21	Outliers
15		M	09/09		\$125,000	\$140,100	112%	25	
				Totals:	\$2,200,000	\$1,886,700		183	
Weighted Average Ratio:		86% (1,886,700/2,200,000)							
Average Ratio:		87% (960/11)							
Average Deviation:		12.2% (183/15)							
Quality Rating:		14 (12.2/87)							

Answers to Class Problems – Chapter 7

Problem 7.3

ITEM NO.		CLASS	MO/YR		SALE PRICE	ASSESSMENT	RATIO	DEV.	
1		R	04/09		\$269,000	\$161,400	60%	27	
2		R	02/09		\$174,500	\$118,700	68%	19	Outliers
3		R	03/09		\$232,500	\$165,100	71%	16	
4		R	02/09		\$199,000	\$143,300	72%	15	
5	1	R	09/09		\$145,000	\$107,300	74%	13	
6	2	R	08/09		\$205,000	\$157,800	77%	10	
7	3	R	01/09		\$158,900	\$122,400	77%	10	
8	4	R	05/09		\$215,000	\$174,200	81%	6	
9	5	R	09/09		\$178,000	\$146,000	82%	5	
10	6	R	11/09		\$209,900	\$176,300	84%	3	
11	7	R	03/09		\$150,000	\$126,000	84%	3	
12	8	R	04/09		\$167,500	\$142,400	85%	2	
13	9	R	04/09		\$239,000	\$207,900	87%	0	Mean
14	10	R	10/09		\$244,000	\$219,600	90%	3	87%
15	11	R	03/09		\$177,700	\$159,900	90%	3	
16	12	R	02/09		\$180,000	\$163,800	91%	4	
17	13	R	07/09		\$224,500	\$206,500	92%	5	
18	14	R	10/09		\$149,000	\$140,000	94%	7	
19	15	R	01/09		\$192,500	\$182,900	95%	8	
20	16	R	05/09		\$136,500	\$129,700	95%	8	
21	17	R	08/09		\$188,000	\$184,200	98%	11	1476
22		R	07/09		\$184,500	\$188,200	102%	15	
23		R	12/09		\$156,600	\$164,400	105%	18	Outliers
24		R	08/09		\$125,000	\$137,500	110%	23	
25		R	12/09		\$149,000	\$177,300	119%	32	
				Totals:	\$4,650,600	\$4,002,800		266	
Weighted Average Ratio:		86% (4,002,800/4,650,600)							
Average Ratio:		87% (1476/17)							
Average Deviation:		10.6 (266/25)							
Quality Rating:		12 (10.6/87)							

Answers to Class Problems – Chapter 7

Problem 7.4

ITEM NO.		CLASS	MO/YR		SALE PRICE	ASSESSMENT	RATIO	DEV.	
1		L	12/09		\$48,900	\$22,000	45%	23	
2		L	04/09		\$46,000	\$22,100	48%	20	
3		L	03/09		\$39,700	\$19,500	49%	19	Outliers
4		R	09/09		\$315,500	\$167,200	53%	15	
5		L	06/09		\$65,000	\$35,800	55%	13	
6		R	11/09		\$258,000	\$149,600	58%	10	
7	1	L	09/09		\$40,000	\$24,000	60%	8	
8	2	L	10/09		\$49,000	\$29,900	61%	7	
9	3	L	02/09		\$52,000	\$32,200	62%	6	
10	4	R	02/09		\$226,500	\$140,400	62%	6	
11	5	R	05/09		\$278,900	\$175,700	63%	5	
12	6	R	12/09		\$198,000	\$126,700	64%	4	
13	7	L	09/09		\$45,000	\$28,800	64%	4	
14	8	R	08/09		\$269,000	\$172,200	64%	4	
15	9	R	02/09		\$205,000	\$133,000	65%	3	
16	10	L	05/09		\$34,500	\$22,400	65%	3	
17	11	R	05/09		\$188,000	\$124,000	66%	2	
18	12	R	04/09		\$322,000	\$212,500	66%	2	
19	13	L	07/09		\$43,000	\$28,500	66%	2	
20	14	L	07/09		\$38,000	\$25,800	68%	0	Mean
21	15	R	06/09		\$164,500	\$111,900	68%	0	68%
22	16	L	08/09		\$42,000	\$28,600	68%	0	
23	17	R	11/09		\$305,000	\$210,500	69%	1	
24	18	R	02/09		\$139,000	\$97,000	70%	2	
25	19	R	01/09		\$297,500	\$208,200	70%	2	
26	20	R	10/09		\$162,500	\$115,400	71%	3	
27	21	R	03/09		\$292,000	\$210,200	72%	4	
28	22	L	06/09		\$32,500	\$23,400	72%	4	
29	23	R	08/09		\$178,000	\$131,700	74%	6	
30	24	L	04/09		\$37,000	\$27,700	75%	7	
31	25	L	03/09		\$34,900	\$26,500	76%	8	
32	26	R	01/09		\$195,000	\$150,000	77%	9	1758
33		R	05/09		\$270,000	\$207,900	77%	9	
34		R	12/09		\$284,900	\$222,200	78%	10	
35		R	08/09		\$136,000	\$108,800	80%	12	Outliers
36		R	11/09		\$265,000	\$225,200	85%	17	
37		R	03/09		\$142,500	\$128,300	90%	22	
38		R	09/09		\$162,000	\$153,900	95%	27	
Totals:					\$5,902,300	\$4,079,700		299	

Weighted Average Ratio:	69% (4,079,700/5,902,300)
Average Ratio:	68% (1758/26)
Average Deviation:	7.9 (299/38)
Quality Rating:	12 (7.9/68)

CLASSIFICATIONS
L=LAND
M=CONDO
R=RESIDENTIAL
W=WATERFRONT

Answers to Class Problems – Chapter 7

Problem 7.6

ITEM NO.		CLASS	MO/YR		SALE PRICE	ASSESSMENT	RATIO	DEV.	
1		R	09/09		\$315,500	\$167,200	53%	17	
2		R	11/09		\$258,000	\$149,600	58%	12	Outliers
3		R	02/09		\$226,500	\$140,400	62%	8	
4	1	R	05/09		\$278,900	\$175,700	63%	7	
5	2	R	12/09		\$198,000	\$126,700	64%	6	
6	3	R	08/09		\$269,000	\$172,200	64%	6	
7	4	R	02/09		\$205,000	\$133,000	65%	5	
8	5	R	05/09		\$188,000	\$124,000	66%	4	
9	6	R	04/09		\$322,000	\$212,500	66%	4	
10	7	R	06/09		\$164,500	\$111,900	68%	2	
11	8	R	11/09		\$305,000	\$210,500	69%	1	
12	9	R	02/09		\$139,000	\$97,000	70%	0	Mean
13	10	R	01/09		\$297,500	\$208,200	70%	0	70%
14	11	R	10/09		\$162,500	\$115,400	71%	1	
15	12	R	03/09		\$292,000	\$210,200	72%	2	
16	13	R	08/09		\$178,000	\$131,700	74%	4	
17	14	R	01/09		\$195,000	\$150,000	77%	7	
18	15	R	05/09		\$270,000	\$207,900	77%	7	
19	16	R	12/09		\$284,900	\$222,200	78%	8	
20	17	R	08/09		\$136,000	\$108,800	80%	10	1194
21		R	11/09		\$265,000	\$225,200	85%	15	
22		R	03/09		\$142,500	\$128,300	90%	20	Outliers
23		R	09/09		\$162,000	\$153,900	95%	25	
				Totals	\$5,254,800	\$3,682,500		171	
Weighted Average Ratio:				70% (3,682,500/5,254,800)					
Average Ratio:				70% (1194/17)					
Average Deviation:				7.4 (171/23)					
Quality Rating:				11 (7.4/70)					

Answers to Class Problems – Chapter 7

Problem 7.7

ITEM NO.		CLASS	MO/YR	SALE PRICE	ASSESSMENT	RATIO	DEV.	
1		W	06/09	\$427,500	\$171,000	40%	23	
2		W	07/09	\$376,000	\$150,400	40%	23	
3		R	03/09	\$259,000	\$106,200	41%	22	Outliers
4		W	11/09	\$419,000	\$175,900	42%	21	
5		R	10/09	\$249,000	\$109,600	44%	19	
6	1	W	02/09	\$400,000	\$180,100	45%	18	
7	2	W	05/09	\$365,000	\$171,500	47%	16	
8	3	R	05/09	\$245,000	\$117,600	48%	15	
9	4	W	04/09	\$395,000	\$189,600	48%	15	
10	5	R	10/09	\$222,500	\$111,300	50%	13	
11	6	W	09/09	\$399,000	\$203,500	51%	12	
12	7	W	02/09	\$445,000	\$235,800	53%	10	
13	8	W	12/09	\$386,900	\$212,800	55%	8	
14	9	W	04/09	\$355,000	\$195,200	55%	8	
15	10	W	07/09	\$349,000	\$198,900	57%	6	
16	11	R	06/09	\$214,500	\$128,700	60%	3	
17	12	W	11/09	\$389,000	\$241,200	62%	1	
18	13	W	12/09	\$345,500	\$214,200	62%	1	Mean
19	14	R	03/09	\$188,000	\$122,200	65%	2	63%
20	15	W	02/09	\$375,000	\$243,700	65%	2	
21	16	R	06/09	\$139,000	\$94,500	68%	5	
22	17	W	06/09	\$333,000	\$229,800	69%	6	
23	18	R	04/09	\$177,900	\$124,500	70%	7	
24	19	R	08/09	\$227,000	\$163,400	72%	9	
25	20	R	10/09	\$199,000	\$149,200	75%	12	
26	21	R	07/09	\$195,000	\$154,000	79%	16	
27	22	R	05/09	\$134,500	\$110,300	82%	19	
28	23	R	04/09	\$250,000	\$210,000	84%	21	
29	24	R	06/09	\$148,000	\$125,800	85%	22	1507
30		R	12/09	\$164,500	\$141,500	86%	23	
31		R	09/09	\$132,000	\$116,200	88%	25	
32		R	11/09	\$129,000	\$117,400	91%	28	Outliers
33		R	07/09	\$142,500	\$131,100	92%	29	
34		R	04/09	\$130,000	\$123,500	95%	32	
Totals				\$9,306,300	\$5,470,600		492	
Weighted Average Ratio: 59% (5,470,600/9,306,300)								
Average Ratio: 63% (1507/24)								
Average Deviation: 14.5 (492/34)								
Quality Rating: 23 (14.5/63)								

Answers to Class Problems – Chapter 7

Problem 7.8

ITEM NO.		CLASS	MO/YR		SALE PRICE	ASSESSMENT	RATIO	DEV.	
1		R	03/09		\$259,000	\$106,200	41%	33	
2		R	10/09		\$249,000	\$109,600	44%	30	Outliers
3		R	05/09		\$245,000	\$117,600	48%	26	
4	1	R	10/09		\$222,500	\$111,300	50%	24	
5	2	R	06/09		\$214,500	\$128,700	60%	14	
6	3	R	03/09		\$188,000	\$122,200	65%	9	
7	4	R	06/09		\$139,000	\$94,500	68%	6	
8	5	R	04/09		\$177,900	\$124,500	70%	4	
9	6	R	08/09		\$227,000	\$163,400	72%	2	Mean
10	7	R	10/09		\$199,000	\$149,200	75%	1	74%
11	8	R	07/09		\$195,000	\$154,000	79%	5	
12	9	R	05/09		\$134,500	\$110,300	82%	8	
13	10	R	04/09		\$250,000	\$210,000	84%	10	
14	11	R	06/09		\$148,000	\$125,800	85%	11	
15	12	R	12/09		\$164,500	\$141,500	86%	12	
16	13	R	09/09		\$132,000	\$116,200	88%	14	964
17		R	11/09		\$129,000	\$117,400	91%	17	
18		R	07/09		\$142,500	\$131,100	92%	18	Outliers
19		R	04/09		\$130,000	\$123,500	95%	21	
				Totals:	\$3,546,400	\$2,457,000		265	
Weighted Average Ratio: 69% (2,457,000/3,546,400) Average Ratio: 74% (964/13) Average Deviation: 14 (265/19) Quality Rating: 19 (14/74)									

Answers to Class Problems – Chapter 7

Problem 7.9

ITEM NO.		CLASS	MO/YR		SALE PRICE	ASSESSMENT	RATIO	DEV.	
1		W	06/09		\$427,500	\$171,000	40%	12	Outliers
2		W	07/09		\$376,000	\$150,400	40%	12	
3	1	W	11/09		\$419,000	\$175,900	42%	10	
4	2	W	02/09		\$400,000	\$180,100	45%	7	
5	3	W	05/09		\$365,000	\$171,500	47%	5	
6	4	W	04/09		\$395,000	\$189,600	48%	4	
7	5	W	09/09		\$399,000	\$203,500	51%	1	Mean
8	6	W	02/09		\$445,000	\$235,800	53%	1	52%
9	7	W	04/09		\$355,000	\$195,200	55%	3	
10	8	W	12/09		\$386,900	\$212,800	55%	3	
11	9	W	07/09		\$349,000	\$198,900	57%	5	
12	10	W	12/09		\$345,500	\$214,200	62%	10	
13	11	W	11/09		\$389,000	\$241,200	62%	10	577
14		W	02/09		\$375,000	\$243,700	65%	13	Outliers
15		W	06/09		\$333,000	\$229,800	69%	17	
				Total	\$5,759,900	\$3,013,600		113	
Weighted Average Ratio:		52% (3,013,600/5,759,900)							
Average Ratio:		52% (577/11)							
Average Deviation:		7.5 (113/15)							
Quality Rating:		14 (7.5/52)							